



## **R3(s)IP Phone User Manual**

Version: 1.0

2015-05-25

# Content

|  |           |
|--|-----------|
| Contact ATCOM.....                           | 5         |
| <b>1、 Overview of R3(s) .....</b>            | <b>6</b>  |
| 1.1、 Interface .....                         | 7         |
| 1.2、 Hardware .....                          | 7         |
| 1.3、 Software .....                          | 7         |
| 1.4、 Network .....                           | 8         |
| 1.5、 Management and Maintenance .....        | 8         |
| 1.6、 Protocol .....                          | 8         |
| 1.7、 Compliant and Certified Standard .....  | 9         |
| 1.8、 Packing list .....                      | 9         |
| 1.9、 Installation .....                      | 10        |
| <b>2、 Keypad of IP Phone .....</b>           | <b>14</b> |
| 2.1 Describe of the buttons and Screen ..... | 14        |
| 2.2 Line keys LED .....                      | 16        |
| 2.3 Status Indicator .....                   | 16        |
| 2.4 Memory keys LED .....                    | 16        |
| 2.5 LCD screen icons .....                   | 16        |
| <b>3、 Call Function .....</b>                | <b>18</b> |
| 3.1、 Answer the calls .....                  | 18        |
| 3.2、 Make Calls .....                        | 19        |
| 3.3、 Pre-dial .....                          | 20        |
| 3.4、 Multiple line dial-up .....             | 20        |
| 3.5、 Call Hold .....                         | 21        |

|  |           |
|--|-----------|
| 3.6、Call Transfer .....                      | 21        |
| 3.7、Mute calls .....                         | 22        |
| 3.8、3-Way Conference .....                   | 23        |
| 3.9、Hang up the phone .....                  | 23        |
| 3.10、Voicemail .....                         | 24        |
| <b>4、Keypad and GUI .....</b>                | <b>24</b> |
| 4.1、Starting .....                           | 24        |
| 4.2、Standby .....                            | 25        |
| 4.3、Configuration .....                      | 27        |
| 4.3.1、Status info .....                      | 28        |
| 4.3.2、Call Features .....                    | 30        |
| 4.3.3、Directory .....                        | 46        |
| 4.3.4、History .....                          | 52        |
| 4.3.5、Message .....                          | 55        |
| 4.3.6、Settings .....                         | 57        |
| 4.3.7、Display .....                          | 73        |
| <b>5、Advanced Feature .....</b>              | <b>75</b> |
| 5.1、Codecs .....                             | 75        |
| 5.2、Capture and Upgrading .....              | 75        |
| 5.3、Auto Upgrade .....                       | 76        |
| 5.4、Export & Import configuration file ..... | 78        |
| 5.4.1、Export configuration file .....        | 79        |
| 5.4.2、Import configuration file .....        | 80        |
| 5.5、Export System log .....                  | 80        |

|   |           |
|---|-----------|
| 5.6、Dial plan .....                                       | 80        |
| 5.6.1、Replace Rule .....                                  | 81        |
| 5.6.2、Dial-now .....                                      | 82        |
| 5.6.3、Area Code .....                                     | 84        |
| 5.6.4、Block Out .....                                     | 84        |
| <b>6、FAQ.....</b>   | <b>86</b> |
| 6.1、How to reset to factory .....                         | 86        |
| 6.2、Upgrade the firmware on safe mode .....               | 87        |
| 6.3、How to make IP Peer to Peer call .....                | 87        |
| <b>7、Troubleshooting.....</b>                             | <b>88</b> |
| 7.1、The phone is failed to register to SIP server .....   | 88        |
| 7.2、The phone is failed to gain IP address .....          | 88        |
| 7.3、Only one party can hear from another on calling ..... | 88        |
| <b>8、Abbreviation.....</b>                                | <b>89</b> |

## Contact ATCOM

### Overview of ATCOM

ATCOM is the leading VoIP hardware manufacturer in global market. We have been keeping innovating with customer's needs oriented , working with partners to establish a total solution for SMB VoIP with IP phone , IP PBX and Asterisk cards.

With over 10 years' experience of R&D , manufacturing and service in network and VoIP filed;mission of creating the biggest value for IP terminals , we commit ourselves in supplying the competitive IP phone and other terminals for IP PBX , softswitch , IMS , NGN providers and carriers; supplying the competitive total VoIP solution for SMB market. We keep improving the customer's experience and creating the bigger value with our reliable products. Until now, our VoIP products have been available in 100+ countries and used by millions of end users.

### Contact Sales

|         |  |
|---------|--|
| Address | Area C, A2F , Block 3 ,Huangguan Technology Park , #21 Tairan 9th Rd, Chegongmiao , Futian District , Shenzhen China |
| Tel     | + (86) 755-83018618-8806   |
| Fax     | + (86) 755-83018319  |
| E-mail  | <a href="mailto:sales@atcomemail.com">sales@atcomemail.com</a>   |

### Contact Technical Support

|        |  |
|--------|--|
| Tel    | + (86) 755-83018618-8008   |
| E-mail | <a href="mailto:Support@atcomemail.com">Support@atcomemail.com</a> |

**Website Address:** <http://www.atcom.cn/>

**Download Center:** <http://www.atcom.cn/download.html>

# 1、 Overview of R3(s)



R3(s)



R3(s)with Rainbow ET

## 1.1、Interface

|                     |                     |
|---------------------|---------------------|
| <b>Power Input</b>  | DC 5V-2000mA or PoE |
| <b>LAN Port</b>     | RJ45                |
| <b>PC Port</b>      | RJ45                |
| <b>EXPAN Port</b>   | RJ45                |
| <b>Headset Jack</b> | RJ9                 |
| <b>Handset Jack</b> | RJ9                 |

## 1.2、Hardware

|                                    |  |
|------------------------------------|--|
| <b>LCD</b>                         | 461*278 4.3" TFT   |
| <b>FLASH</b>                       | 64M  |
| <b>RAM</b>                         | 64M  |
| <b>CPU</b>                         | R3 262MHz Dual-Core  |
|                                    | R3s 393MHz Dual-Core   |
| <b>LED Indicator</b>               | 1 Status Light , 4 line indicators, 8 BLF indicators, 1 voicemail indicator, 1 headset indicator, 1 mute indicator |
| <b>Rainbow ET Expansion Module</b> | 44 programmable keys on each Rainbow ET.   |

## 1.3、Software

- Sip 2.0 (RFC3261) and other related SIP RFCs
- 4 SIP lines registration
- STUN
- Jitter Buffer, VAD,CNG
- G.711A/u, G.722, G.723, G.726-16, G.726-24, G.726-32, G.726-40, G.729, Lin16-16, iLBC
- Echo Cancellation
- SIP Domain name, Authentication and Backup SIP Server
- DTMF (Inband, RFC2833, SIP INFO)

- Call transfer, Call forward, 3-way conference, Call hold, Call back
- DND(Do Not Disturb), Auto answer, Blacklists, Block Call-ID, Block Anonymous call, Dial plan, IP call
- Phone book with 200 records, 200 answered calls, 200 missed calls, 200 dialed calls
- Auto update via HTTP, FTP, TFTP, PNP
- Syslog
- SNTP,NTP
- Customized Ringtone
- Daylight Saving time
- VLAN, VPN
- WEB access with different login level
- Multi-language:English, Chinese, Farsi, French, German, Hebrew, Italian, Portuguese, Russian, Spanish, Turkish

## 1.4、 Network

- LAN/PC:Support Bridge mode
- Support VLAN
- Support L2TP VPN
- Support DHCP、STATIC、PPPoE
- Primary/SecondaryDNS Server
- Support QoS
- Web access via HTTP&HTTPS

## 1.5、 Management and Maintenance

- Support safe mode and firmware updating under safe mode
- Support different level user management
- Configuration via web , keyboard
- Support multi-language
- Firmware and configuration file auto provision
- Support system log

## 1.6、 Protocol

- IEEE 802.3 /802.3 u 10 Base T / 100Base TX
- PPPoE: PPP over Ethernet



- DHCP: Dynamic Host Configuration Protocol
- SIP RFC3261, RFC3262, RFC3263, RFC3264, RFC3265, RFC2543, RFC3489, RFC3842, RFC3515, RFC2976, RFC3428, RFC2327, RFC2782, RFC1889
- TCP/IP: Transfer Control Protocol/Internet Protocol
- RTP: Real-time Transport Protocol
- RTCP:RTP Control Protocol
- DNS: Domain Name Server
- TFTP: Trivial File Transfer Protocol
- HTTP:Hypertext Transfer Protocol
- FTP:File Transfer Protocol

## 1.7、Compliant and Certified Standard

- CE: AGC01180140201E2, AGC01180140202E2
- Comply with ROHS in EU
- Comply with ROHS in China



- Operation temperature: lower than 60° C
- Storage temperature: lower than 60° C
- Humidity: 10 to 90% no dew

## 1.8、Packing list

| Model            | R3(s)              |
|------------------|--------------------|
| Telephone        | 1Unit              |
| Handset          | 1Unit              |
| Handset cable    | 1Unit              |
| Stand bracket    | 1Unit              |
| Power adapter    | Optional           |
| Network Cable    | 1 unit, 1.5 meters |
| CD (User manual) | 1Unit              |
| Rainbow ET       | Optional           |

|                |          |
|----------------|----------|
| <b>Headset</b> | Optional |
|----------------|----------|

## 1.9、 Installation

R3(s) is able to be connected with network via LAN port. Under the Bridge mode, other devices (Laptop, IP phone) is able to access network via the PC port of R3(S).



### 1、 Stand bracket installation instruction

A. Put the bottom side of the IP phone upside and press one-side joints of stand bracket into the slot, please refer the picture as below:

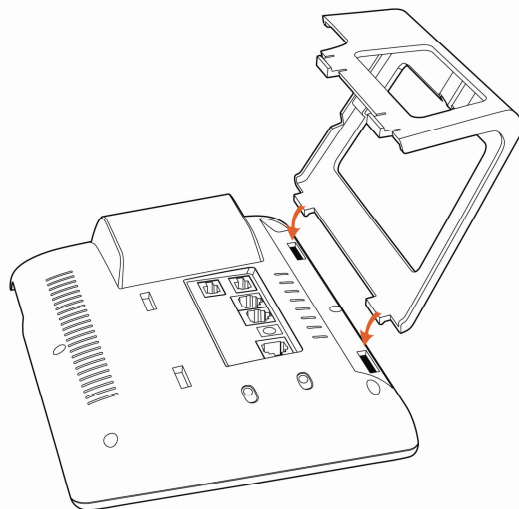

B. Press the other side joints into the slot according to the direction of the arrow:

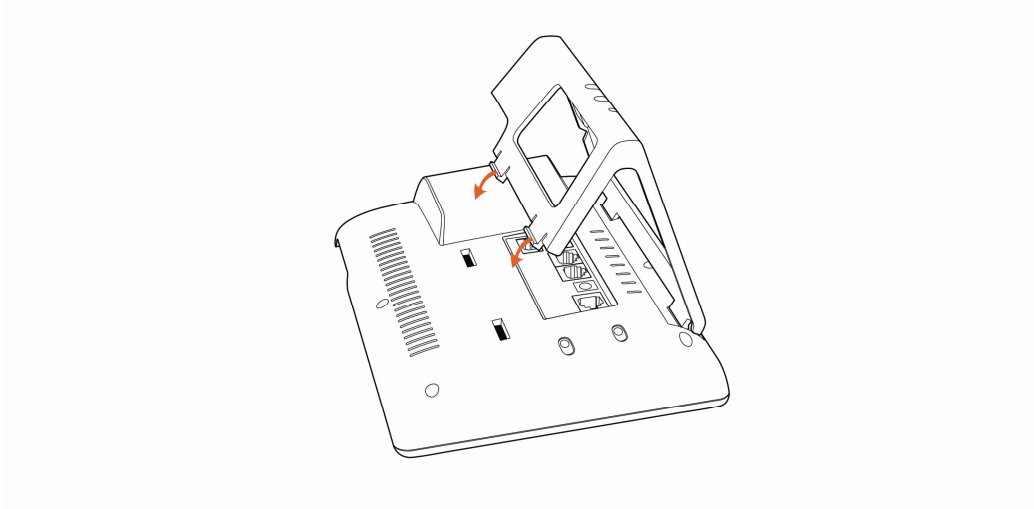

C. It is the right picture after fixing the stand bracket below:

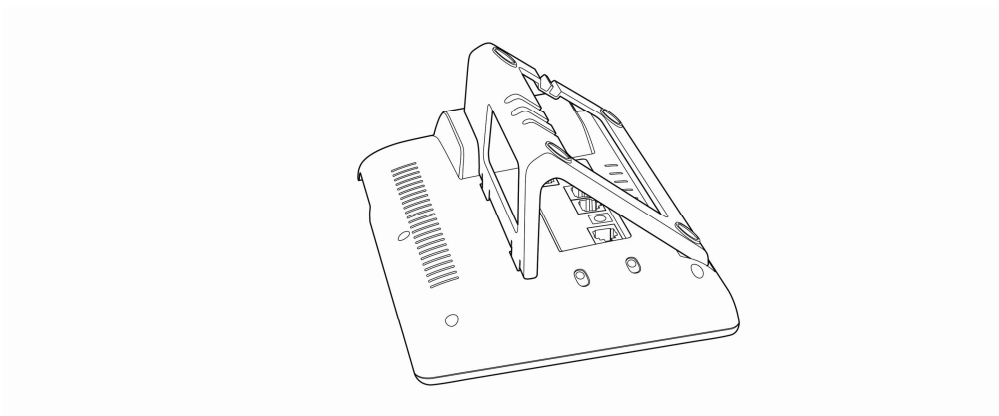

D. Disassemble the stand bracket:

Push the spring joint of stand and pull the stand according to the direction of the arrow. When the joints are pulled out of the slot, you can take off the stand bracket

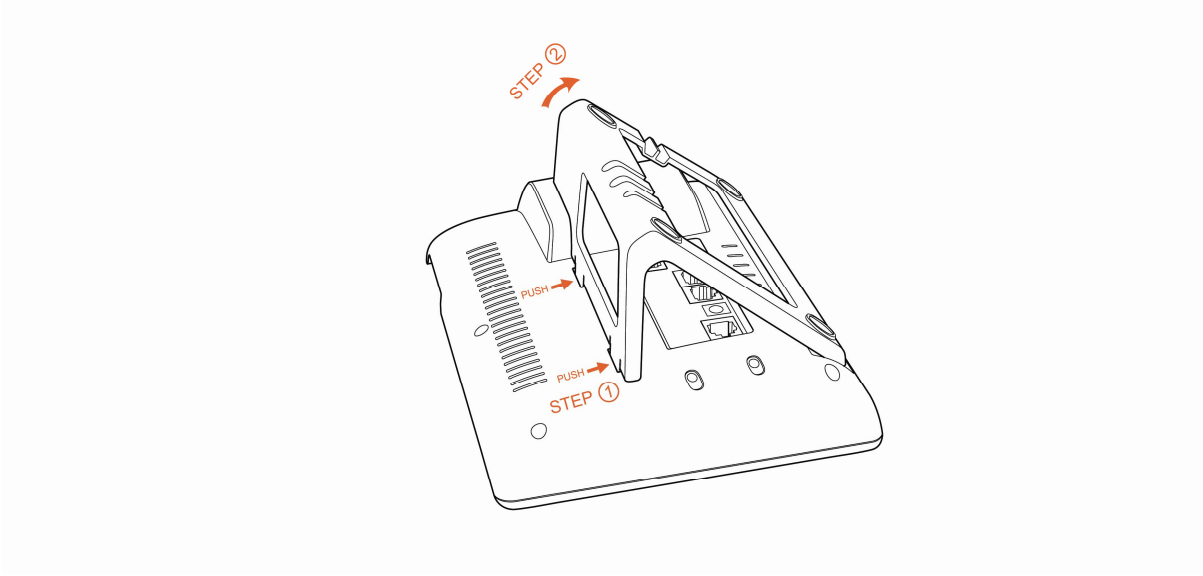

## 2. Wiring instruction

Plug in the power adapter, cable and handset or headset to the corresponding ports as below picture and press them to the slots on the stand bracket.

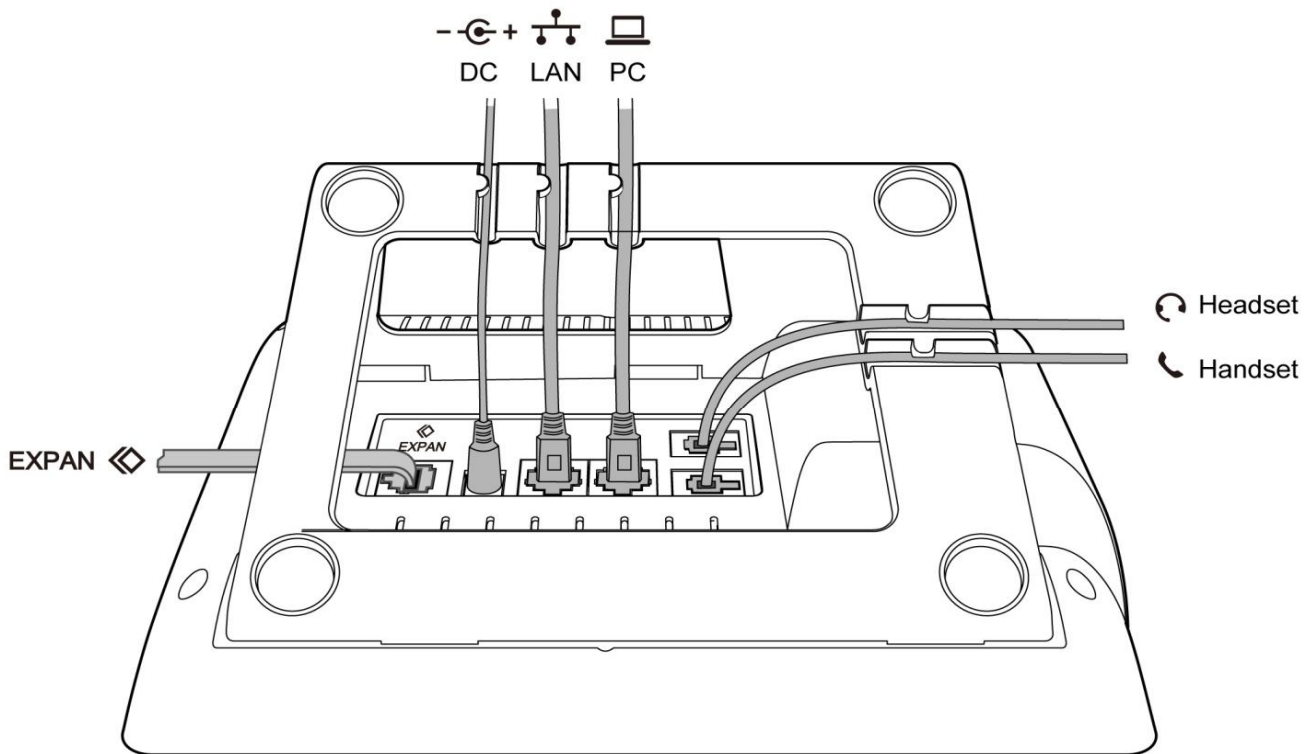

### Programmable keys' paster using instruction

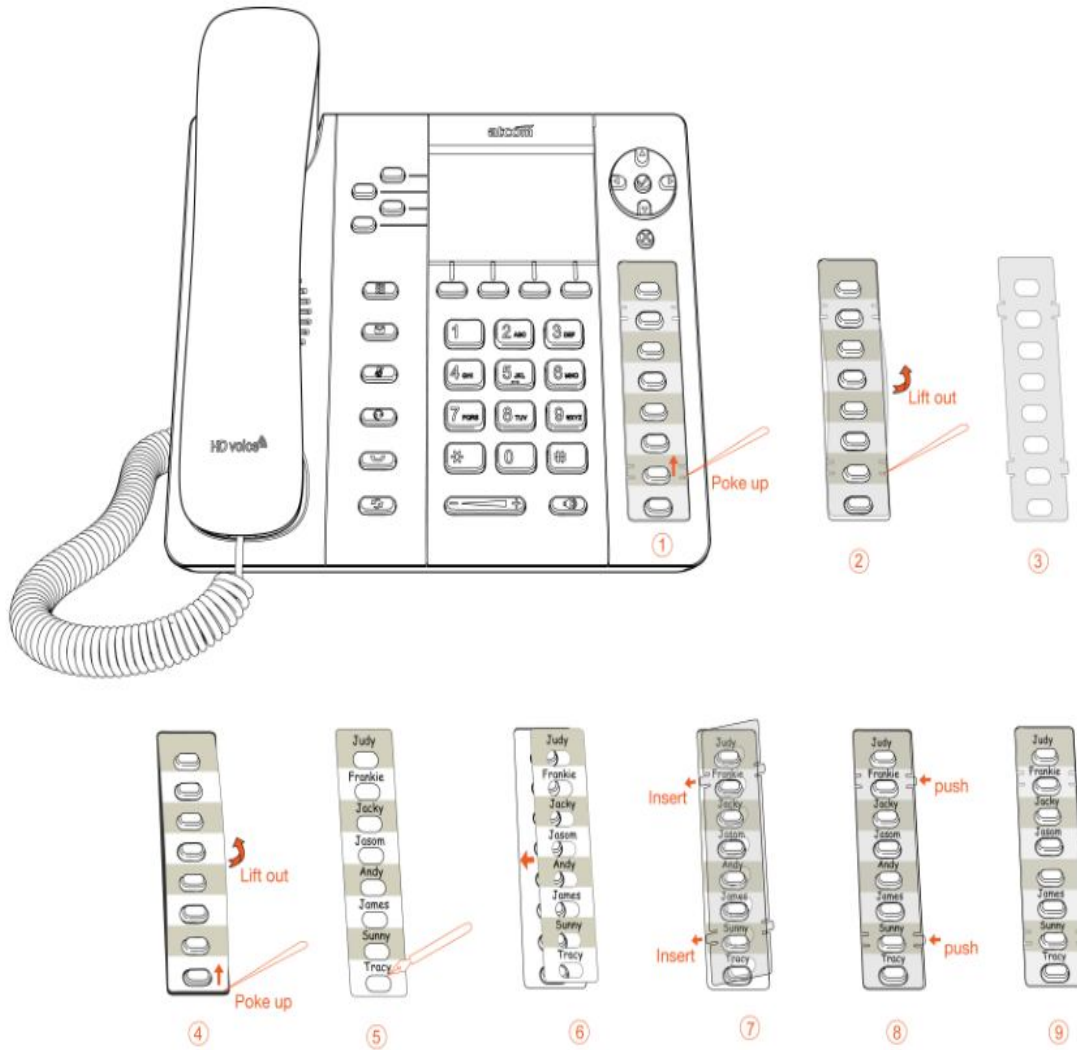

Step1. Use needle or some other tools to insert into the hole of the plastic sheet, hog the plastic sheet.

Step2. Lift out the plastic sheet

Step3. Take off the plastic sheet

Step4. Use needle or some other tools to insert into the edge of the paster, hog and lift out the paster

Step5. Write down the identification of each programmable key on the paster after taking off the paster

Step6. Put back the paster

Step7. Insert the plastic sheet into the slot





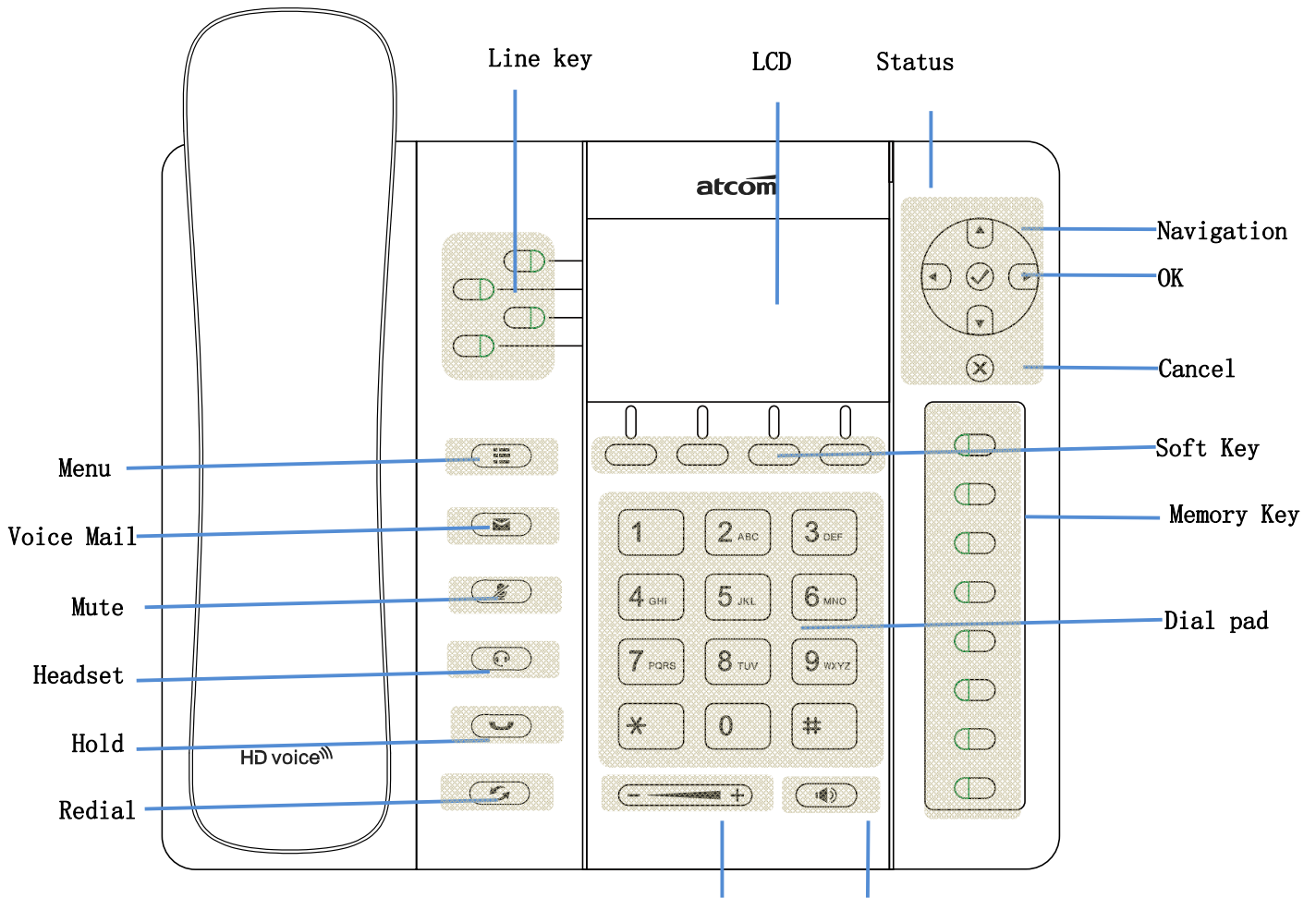





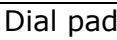

Step8. Push the other side of the plastic sheet into the other slot

## 2、Keypad of IP Phone



### 2.1 Describe of the buttons and Screen

|                  |   |
|------------------|---|
| Soft Keys        | Press to select a function which displayed at the softkey zone of screen<br><br>Display all optional functions at the last line of LCD screen                           |
| Status Indicator | Indicates the phone's status.   |
| LCD Screen       | All information such as date, time, phone number, incoming caller's ID(if available),line/call status, extension numbers and the soft key features are displayed on it. |
| Line Key         | Show extension status and choose corresponding line. Long hold the line key will enter the editor interface.  |

|   |   |
|---|---|
|    | Entering numbers or characters.   |
| Memory Keys   | All the memory keys can be defined as BLF key, intercom, DTMF etc. Long hold the programmable key will enter the editor interface if the programmable key has been already defined as the BLF/Speeddial/Intercom/Key event as pick up, call park, DTMF etc. Short hold the programmable key will enter the editor interface immediately if the programmable has not been defined. |
| Navigation keys   | Allow users to navigate(left, right, up, down). Press  can enter "Directory". Press  can enter "History".   |
|    | Confirm users' operation and show status when R3 is idle.   |
|    | Cancel users' operation.  |
|   | Enter menu settings.  |
|  | Adjust the volume (speaker/handset/headset/ring). Volume level will be displayed on LCD when pressing volume key.   |
|  | Pick up and hung up under the speaker mode.   |
|  | Mute the mic in a conversation by pressing the Mute button; this prevents the person on the active call from hearing what you or someone else in the room is saying.<br><br>If the call is muted, the mute LED is lighted in red.<br><br>To un-mute, press the Mute button again.   |
|  | Pick up and hung up under headset mode. The LED button will be lighted when talking in headset mode.  |
|  | Check the Voicemail status. The LED button will be lighted when there is a new message. Long hold will enter the editor interface to configure the voicemail number.  |
|  | Hold the current call.  |
|  | Redial the last dialed number.  |

## 2.2 Line keys LED

| LED Status                            | Description                               |
|---------------------------------------|---|
| Off                                   | The line is idle or disabled for register |
| Blink in green at 120ms off, 120ms on | The line has incoming call                |
| Green                                 | The line is talking                       |
| Blink in red at 600ms off, 600ms on   | The line is held                          |

Table1Line keys LED Status and Description

## 2.3 Status Indicator

| LED Status                          | Description            |
|-------------------------------------|------------------------|
| On                                  | R3 is being started    |
| Off                                 | R3 is standby          |
| Blink in red at 120ms on, 120ms off | There is incoming call |

Table2 Status Indicator LED Status and Description

## 2.4 Momery keys LED

| LED Status        | Description                           |
|-------------------|---------------------------------------|
| Off               | The monitored account is unregistered |
| Green             | The monitored account is idle         |
| Red               | The monitored account is talking      |
| Fast blink in red | The monitored account is ringing      |

Table3 Programmable keys LED Status and Description

When powering on, all LEDs will be lighted once.

## 2.5 LCD screen icons

















| Icon  | Description  |
|---|--|
|    | The extension is registered  |
|    | The extension is unregistered  |
|    | There is a new voice mail  |
|    | R3 is dialing  |
|    | R3 is talking  |
|    | R3 is calling  |
|    | There is an incoming call  |
|    | The call is held   |
|   | R3 is in speaker mode  |
|  | R3 is in handset mode  |
|  | R3 is in headset mode  |
|  | R3 is in conference  |
|  | The line key is used as the BLF key and the BLF monitored number is registered   |
|  | The line key is used as the BLF key and the BLF monitored number is unregistered |
|  | The line key is used as SpeedDial key  |



Table4 LED Screen Icons Description

## 3、 Call Function



### 3.1、 Answer the calls

When there is an incoming call, phone will remind user with ringing. There are 3 ways to answer the call:



#### A. Answer by handset

Pick up the handset and talk with the caller. If you want to hang up, just put back the handset. When you are talking with the handset and want to switch to speaker or headset mode, please press  key or  key, and then put down the handset.

#### B. Answer by speaker

Press  key and talk with callers by built-in Micro-phone and Speaker. If you want to hang up, please press  key again. Switch calling or talking into handset mode by lifting the handset under speaker mode. Press  key will switch calling or talking into headset mode.

#### C. Answer by headset

Keep your microphone connected with the RJ9 headset jack, when there is an incoming call, press  and talk with the caller. If you want to hang up, please press  again. Pressing  can change calling or talking into speaker mode, and lifting the handset switches to handset mode.

## 3.2、 Make Calls

### A. Use the handset

Pickup the handset, the LCD will show the current lines (user is able to switch from line1 to line4 by pressing the line key beside the LCD). Press soft key "**Send**" to dial the number. When you hear the tones of "du~~du~~" and the phone number your dialed is being displayed on the LCD, the phone at the side of being called should be ringing. If the called party answers this calling, the call is established and the calling timer is started immediately.

### B. Use the speaker

Press  key, the LCD will show the current lines (user is able to switch from line1 to line4 by pressing the line key beside the LCD). Input the phone number and press soft key "**Send**" to dial the number. When caller hear the tones of "du~~du~~" and the phone number your dialed is being displayed on the LCD, the phone at the side of being called should be ringing. If the called party answers this calling, the call is established and the calling timer is started immediately.

### C. Use the headset

Press  Key, the LCD will show the current lines (user is able to switch from line1 to line4 by pressing the line key beside the LCD). Input the phone number and press soft key "**Send**" to dial the number. When caller hear the tones of "du~~du~~" and the phone number your dialed is being displayed on the LCD, the phone at the side of being called should be ringing. If the called party answers this calling, the call is established and the calling timer is started immediately.

### D. Dial from phone book

1. Press  key to enter the menu and choose "**Directory**" option. Press "**Enter**" soft key and then find the contact person by navigation keys. When the certain contact person is highlighted, press "**Dial**" or just pick up the handset to call this number.
2. Pick up the handset, press "**Directory**" soft key, then find the contact person and press "**Dial**" soft key.

3. Pick up the handset, press  and enter "**Directory**", then find the contact person and press "**Dial**" soft key.

E. Dial from call history

1. Press  key to enter the menu and choose "**History**" option, then select one of call history entry, and press "**Dial**" soft key or pickup the handset to call this number.

2. Pickup the handset, press "**History**" soft key, then select one of call history entry, and press "**Dial**" soft key to call this number.



3. Pickup the handset, press  and enter "**Call History**", then select one of call history entry, and press "**Dial**" soft key to call this number.

### 3.3、 Pre-dial

It's a method to dial a phone number immediacy at standby mode.

The method is as below:

A. Dial-up the phone number at standby mode



B. Press soft key "**Dial**" or Pick up the handset or Press  or  to send out the number.

### 3.4、 Multiple line dial-up

R3(s) supports 4 SIP lines. That means user can register 4 different sip accounts simultaneity. User is able to choose line1, line2, line 3 or line 4 by pressing corresponding line key. Line1 or the 1<sup>st</sup> Line registered successfully under idle is the priority to pick up the calls.



R3(s) maximum supports 24 concurrent calls, that means 24 calls can be setup on each of single line, but the total number of concurrent calls on all lines can not more than 24. When there is an incoming call to another line, LCD will show the incoming phone number and line LED will be blinking in green. User is able to press the corresponding line key or press soft key

**"Hold"** the current line on which you're talking then press **"Answer"** to receive the incoming call from another line.

Pick up a new incoming call while on calling: When a new incoming call happened on the being occupied line, press the key  or  to check details of the new incoming call, and press the soft key **"Answer"** on GUI to pick up the new call. The current calling will be hold after the new call picked up. When a new incoming call happened on another idle line, the source phone number of new incoming call will be displayed on the Screen and the LED of corresponding line key will be fast blinking (Green), Press the corresponding line key to pick up the new call, Or Press the soft key **"Hold"** to hold the current call and then press **"Answer"** key to pick up the new call.

Make a new call while on calling: To make a new call on a being occupied line, Press the key **"Hold"**, then input the destination phone number and press the key **"Dial"**, or Press the soft key "New", then input the destination phone number and press the key **"Dial"**. To make a new call on an idle line, press the corresponding line key, input the destination phone number and press the key **"Dial"**.

### 3.5、 Call Hold

The current calling will be hold by pressing soft key **"Hold"** or , and the held call will be resumed after pressing soft key **"Resume"** or  or the corresponding line key. Even on 3-way conference calling, the conference will be held after pressing **"Hold"** key, and be resumed to 3-way conference after pressing **"Hold"** Key again. Remember the conversation is still on hold without being ended even if hung up under the status of hold.

### 3.6、 Call Transfer

#### 1. Attended call transfer

The attended transfer allows user to call a third-party before transferring the calling.

While calling, press the "**Transfer**" soft key to hold the current call and dial the target number you want to transfer to on the activated line and press "**Send**" soft key to call that number. After the target party answers the call, press "**Transfer**" soft key again to complete the transfer.

If the target number has been setup in the current BLF list, and you have already finished the necessary setup on Webpage of R3(s), there is an easier way to complete the attend transfer. While calling, press the corresponding BLF key of the target number and then press the "**Transfer**" soft key, the attend transfer will be achieved.

Setup BLF list with attend transfer functions on Webpage:

**"Phone"→"Features"→"Transfer Settings"→"Transfer Mode via DSS Key (Attend Transfer)"**

## 2. Blind call transfer

The blind transfer allows user to transfer a call without speaking to the third party. On the user side, the call will be ended as soon as the target phone number is dialed.

Operating steps: Press "**Transfer**" soft key to get more option, then press "**Blind**" soft key, input the transfer target number and press "**Send**" soft key.

If the target number has been setup in the current BLF list, and you have already finished the necessary setup on Webpage of R3(s), there is an easier way to complete the Blind transfer. While calling, press the corresponding BLF key of the target number, the blind transfer will be achieved.

Setup BLF list with blind transfer functions on Webpage:

**"Phone"→"Features"→"Transfer Settings"→"Transfer Mode via DSS Key (Blind Transfer)"**

## 3.7、Mute calls

The input audio will be not transmitted to peer phone after pressing  key, and the phone will be muted even switched among different modes of speaker, handset and headset.

To un-mute, just press  key again.

### 3.8、3-Way Conference

1. While on calling, press the soft key "**Conf**", input the 3<sup>rd</sup> party's phone number and then press the softkey "**Dial**" or press the soft key "**Conf**" and press the corresponding BLF key to invite the 3<sup>rd</sup> party to join a conference call.
2. After the third party answers the call, pressing "**Conf**" key again to establish the 3-way conference
3. The initiator of 3-way conference can press the soft key "**Hold**" to hold the conversation with other two parties, and press "**Resume**" to back to 3-way conference.
4. If the initiator hangs up the call or press the soft key "**End Conf**", the conference will be ended and the calling between the other two parties will be hung up as well.
5. The initiator of 3-way conference can press the soft key "**Split**" to separate the conference call, and the calling between initiator and the other two parties are still active but under the status of Call hold.

### 3.9、Hang up the phone

1. Softkey hang up

While on calling, press the softkey "**End Call**" to hang up.

2. Handset hang up

Put back the handset at handset mode, the current calling will be hung up.

3. Speaker hang up

Press  key at speaker model, the current calling will be hung up.

4. Headset Hang up

Press  key at headset model, the current calling will be hung up.

#### 5. Hang up one line call

Press the hook to hang up the current calling when 2 calls happened simultaneously.

## 3.10、 Voicemail

R3(s) has a  key for entering voicemail box and indicating new voicemail. Press

 key to enter the menu to configure voicemail number if you have never configured it previously. Otherwise, the voicemail number will be called after pressing it.

## 4、 Keypad and GUI

### 4.1、 Starting

All lights will be on (Red) at the moment when the phone powered on, and then light off in the following One second. And then the phone turns to standby status in about 50 seconds.







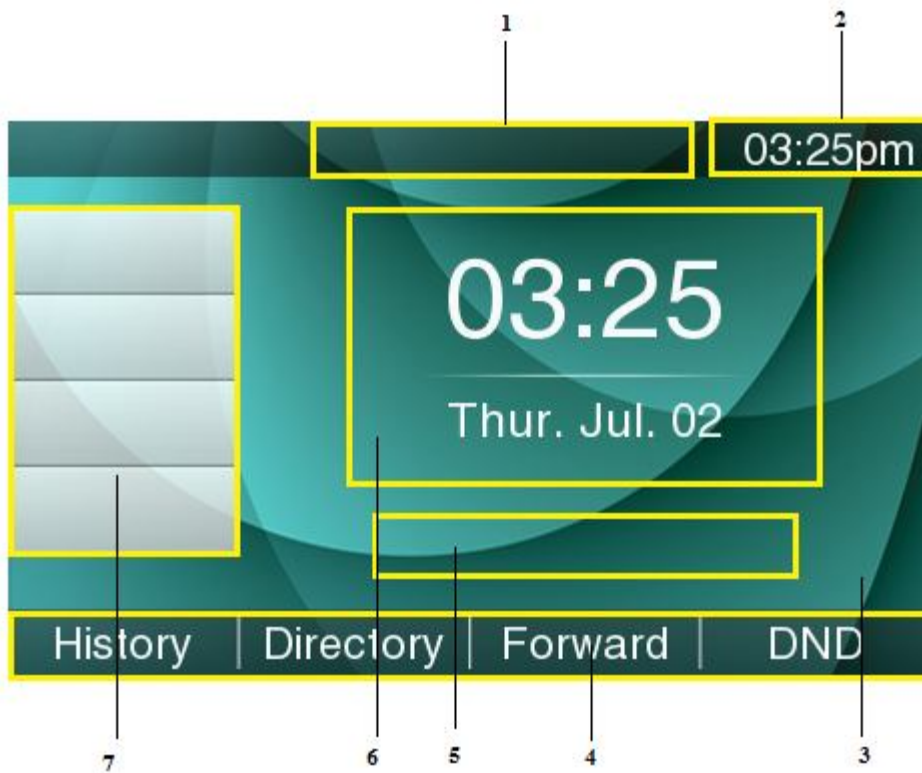













## 4.2、Standby



| Area Item | Description  |
|-----------|--|
| 1         | Status: to indicate the call status  |
| 2         | Time   |
| 3         | Background   |
| 4         | Softkey: <b>"History"</b> , <b>"Directory"</b> , <b>"Forward"</b> , <b>"DND"</b>               |
| 5         | Indication info : DND (on) 、 Missed calls, Call Forward (on) and Network Status (unavailable). |
| 6         | Time, Date   |
| 7         | Programmable keys (Line Keys in default)   |

## Icon on Standby UI

| Icon  | Description  |
|---|--|
|    | The account is registered successfully, and displayed in the Area 7.     |
|  | The account is not registered successfully, and displayed in the Area 7. |
|  | The line is being occupied for dialing, and displayed in the Area 7.     |
|  | The line is on calling, and displayed in the Area 7.                     |
|  | New incoming call, and displayed in the Area 7.                          |
|  | Call hold, and displayed in the Area 7.                                  |
|  | 3-way conference calling, and displayed in the calling UI.               |
|  | Call being hold, and displayed in the calling UI.                        |
|  | Unavailable Network, and displayed in the Area 5.                        |
|  | Calling via handset, and displayed in the Area 1.                        |
|  | Calling via Speaker, and displayed in the Area 1.                        |
|  | Calling via headset, and displayed in the Area 1.                        |

|   |   |
|---|---|
|  | Call Forward is activated, and displayed in the Area 1. |
|  | New Voicemail, and displayed in the Area 1.             |
|  | Volume turn to be "0", and displayed in the Area 1.     |
|  | Auto-Answer is activated, and displayed in the Area 1.  |
|  | DND is activated, and displayed in the Area 1.          |

### 4.3、 Configuration

Press the key  to enter the Main Menu:



Move the cursor via navigation key and press the softkey "**Enter**" or input the corresponding Number key Select the item of Main Menu:

|                |                 |
|----------------|-----------------|
| Number Key "1" | Enter "Status"  |
| Number Key "2" | Enter "Feature" |

|                |                   |
|----------------|-------------------|
| Number Key "3" | Enter "Directory" |
| Number Key "4" | Enter "History"   |
| Number Key "5" | Enter "Message"   |
| Number Key "6" | Enter "Settings"  |
| Number Key "7" | Enter "Display"   |

### 4.3.1、 Status info



It's able to check the status info via LCD Display or Web.

And the basic status and details status will be optional displayed on LCD display

1. Basic Status——IP address、 MAC address、 Firmware version。
2. Details Status——Network info、 Production info and Account info in details.

#### Basic Status

You're able to check the basic status in both ways as below:

1. **Press the key**  **on standby.**
2. **Press the key**  **and select the "Status" of Main Menu.**



3. Input the username and password, the default user and password for Administrator is (admin, admin), for general user is (user, user), and then press "**Enter**".
4. By default, the Status info will be displayed.

### 4.3.2、 Call Features

In this part, we will introduce the following content:

- [Call Forward](#)
- [Call Waiting](#)
- [Auto Answer](#)
- [Programmable keys](#)
- [Key as send](#)
- [Hotline](#)
- [Anonymous Calls](#)

#### Call Forward

"Call Forward" includes "Always Forward "," Busy Forward", "No Answer Forward".

"Always Forward" has the highest priority, and "Busy Forward" has the same priority as "No Answer Forward", that means once the function of "Always Forward" is activated, other call forward features will be unavailable.

Any type of Call forward feature is activated, the Icon  will be indicated on the LCD Display, and the soft key "Forward"(at the bottom line of LCD display) will turn to be "-Forward".

#### Always Forward

All incoming calls will be forwarded to target phone number once the “**Always Forward**” activated, setup this feature as follow:

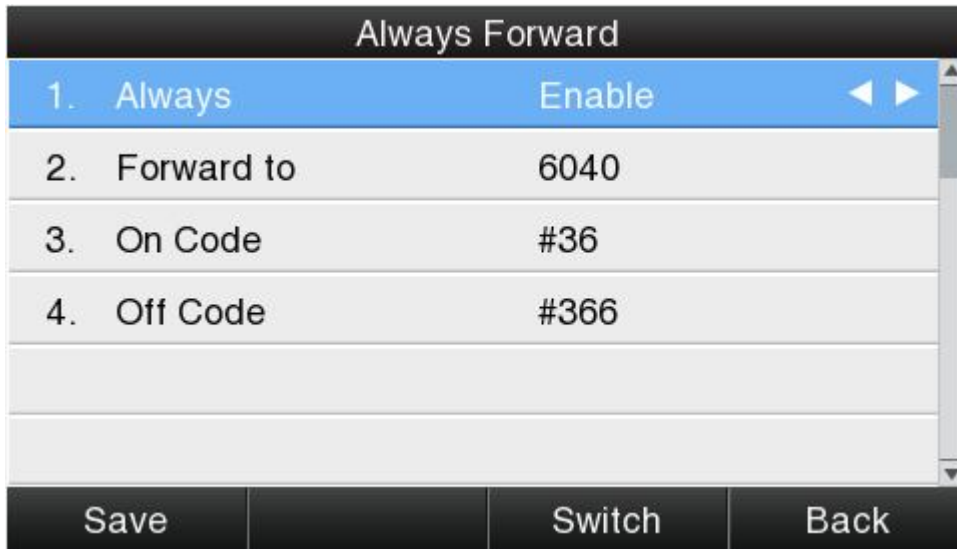



| Item              | Operation  | Description   |
|-------------------|--|---|
| <b>Always</b>     | Press the key  or the soft key “ <b>Switch</b> ” to setup | Switch on or Switch off the feature. “ <b>Enable</b> ” mean this feature is enabled, “ <b>Disable</b> ” mean this feature is disabled.    |
| <b>Forward to</b> | The Number key, “*”key, and “#”are permitted to be input.  | Setup the target phone number which all incoming calls transferred to   |
| <b>On Code</b>    | The Number key, “*” key, and “#”are permitted to be input.   | The feature code to enable all incoming calls forward, the phone will send the feature code directly to open all incoming calls forward   |
| <b>Off Code</b>   | The Number key, “*” key, and “#”are permitted to be input.   | The feature code to disable all incoming calls forward, the phone will send the feature code directly to close all incoming calls forward |

### Busy Forward

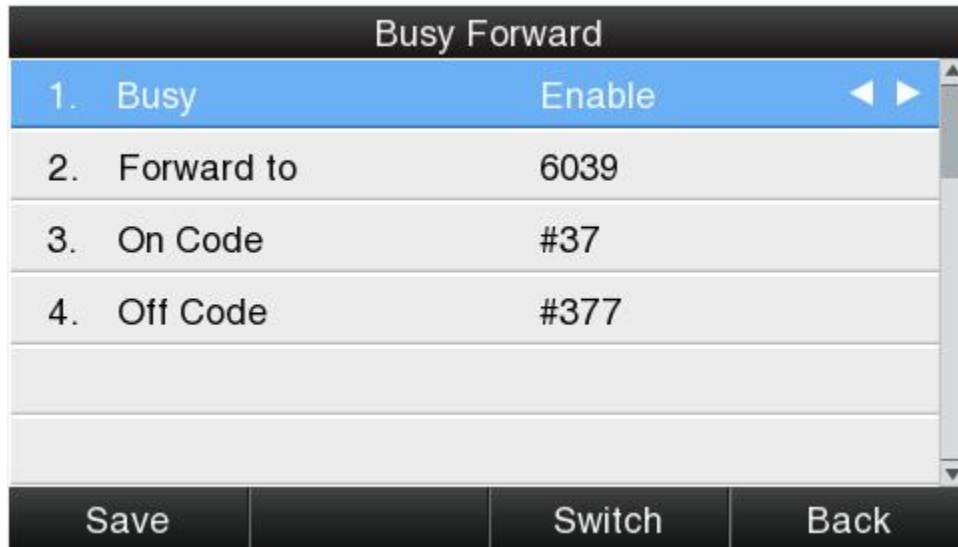
It means the phone is busy once the phone is not at standby mode. Setup this feature as below:







| Item              | Operation  | Description  |
|-------------------|--|--|
| <b>Busy</b>       | Press the key  or  or softkey " <b>Switch</b> " to setup | Switch on or Switch off the feature. " <b>Enable</b> " mean this feature is enabled, " <b>Disable</b> " mean this feature is disabled. |
| <b>Forward to</b> | The Number key, "*"key, and "#"are permitted to be input.  | Setup the target phone number which all incoming calls transferred to  |
| <b>On Code</b>    | The Number key, "*"key, and "#"are permitted to be input.  | The feature code to enable busy calls forward, the phone will send the feature code directly to open busy call forward                 |
| <b>Off Code</b>   | The Number key, "*"key, and "#"are permitted to be input.  | The feature code to disable busy calls forward, the phone will send the feature code directly to close busy call forward               |

## No Answer Forward

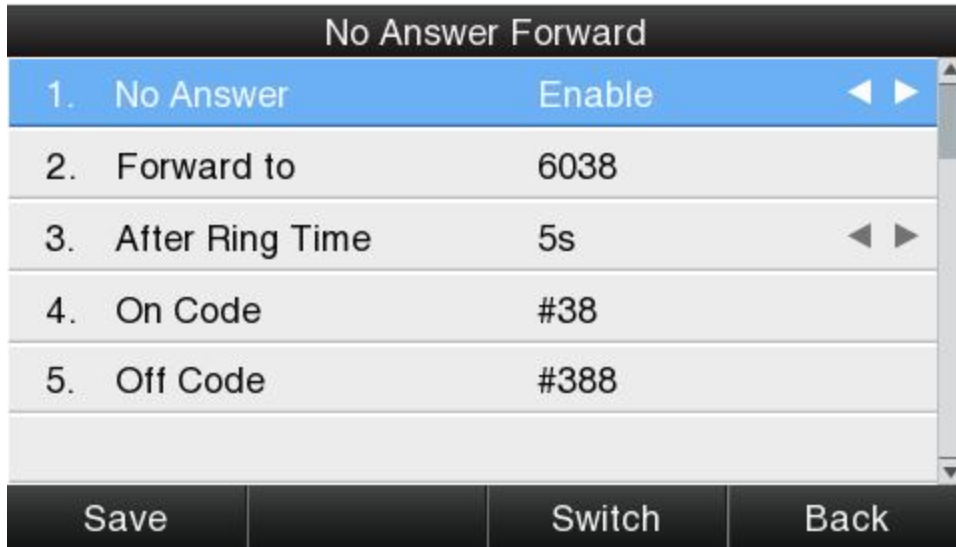
All incoming calls will be forwarded after time out, once the feature of "NoAnswer Forward" is activated. Setup this feature as below,





| Item                   | Operation  | Description   |
|------------------------|--|---|
| <b>No Answer</b>       | Press the key  ,  or softkey " <b>Switch</b> " to setup    | Switch on or Switch off the feature. " <b>On</b> " mean this feature is activated, " <b>Off</b> " mean this feature is unactivated .      |
| <b>Forward to</b>      | The Number key, "*"key, and "#"are permitted to be input.  | Setup the target phone number which all incoming calls transferred to   |
| <b>After Ring Time</b> | Press the key  ,  or softkey " <b>Switch</b> "to setup | Setup timer for no answer status. All incoming calls will be forwarded after time out once Call forward when no answer activated.         |
| <b>On Code</b>         | The Number key, "*"key, and "#"are permitted to be input.  | The feature code to enable no answer call forward, the phone will send the feature code directly to open all incoming calls forward       |
| <b>Off Code</b>        | The Number key, "*"key, and "#"are permitted to be input.  | The feature code to disable all incoming calls forward, the phone will send the feature code directly to close all incoming calls forward |

### Setup Call Forward Via Web



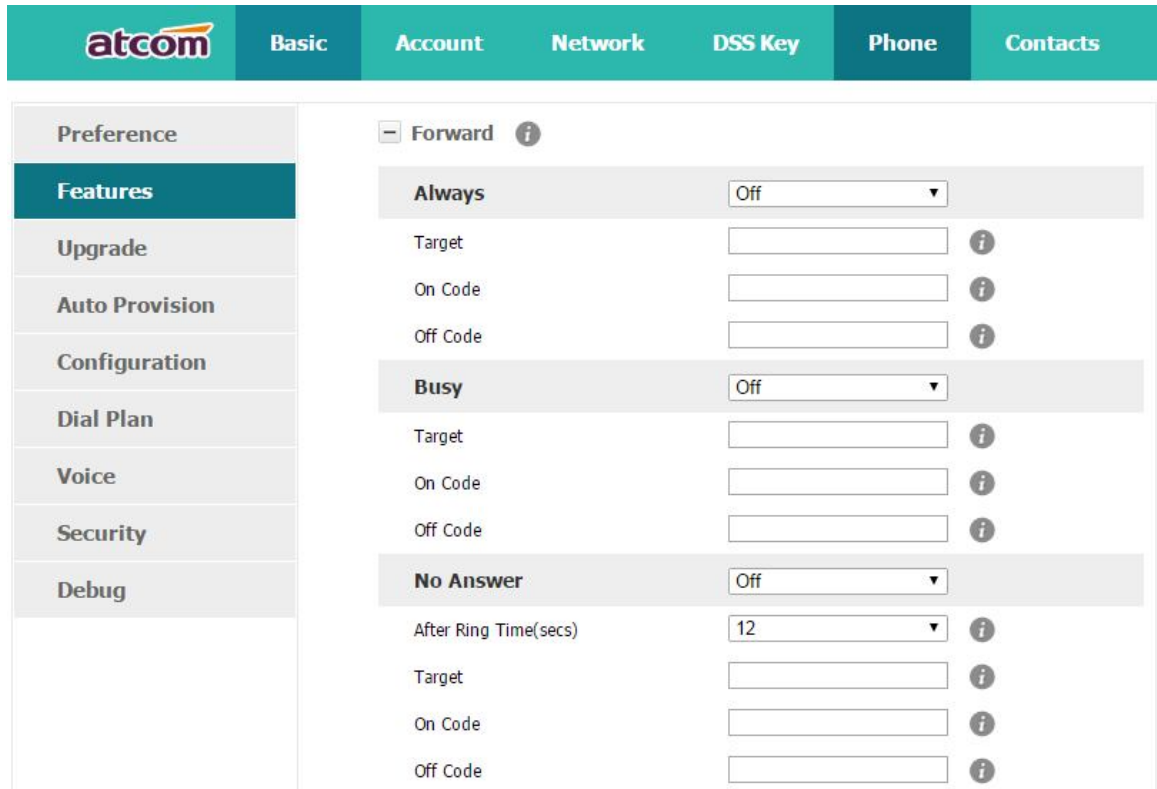

Set Call Forward via web:**Phone**→**Features**→**Forward**.

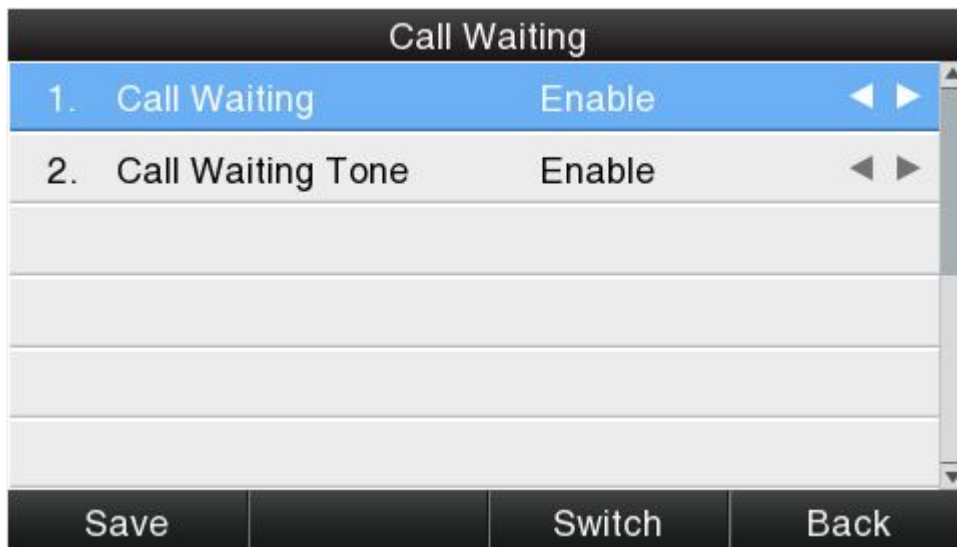

### Call Waiting

The feature of "Call Waiting" is available by default. If switch off this feature, whatever multiple SIP accounts had been registered successfully, only one single active calling is permitted (for example Dialing, Ringing, Calling, Holding).



| Item                     | Operation  | Description  |
|--------------------------|--|--|
| <b>Call Waiting</b>      | Press the key  、 <br>or softkey " <b>Switch</b> " to setup | Switch on or Switch off the feature. " <b>Enable</b> " mean this feature is enabled, " <b>Disable</b> " mean this feature is disabled.         |
| <b>Call Waiting Tone</b> | Press the key  、 <br>or softkey " <b>Switch</b> " to setup | Switch on or Switch off the prompt playing. " <b>Enable</b> " mean this feature is enabled, " <b>Disable</b> " mean this feature is disabled . |

Setup call waiting via web: "**Phone**" → "**Feature**" → "**General information**" → "**Call Waiting**".

Setup call waiting Tone via web: "**Phone**" → "**Feature**" → "**Audio Settings**" → "**Call Waiting Tone**".

## Auto Answer

The feature of "Auto Answer" is switched off by default. All incoming calls will be answered automatically when the phone is standby once "Auto Answer" is activated. "Auto Answer" when the phone is under "on Calling" status.

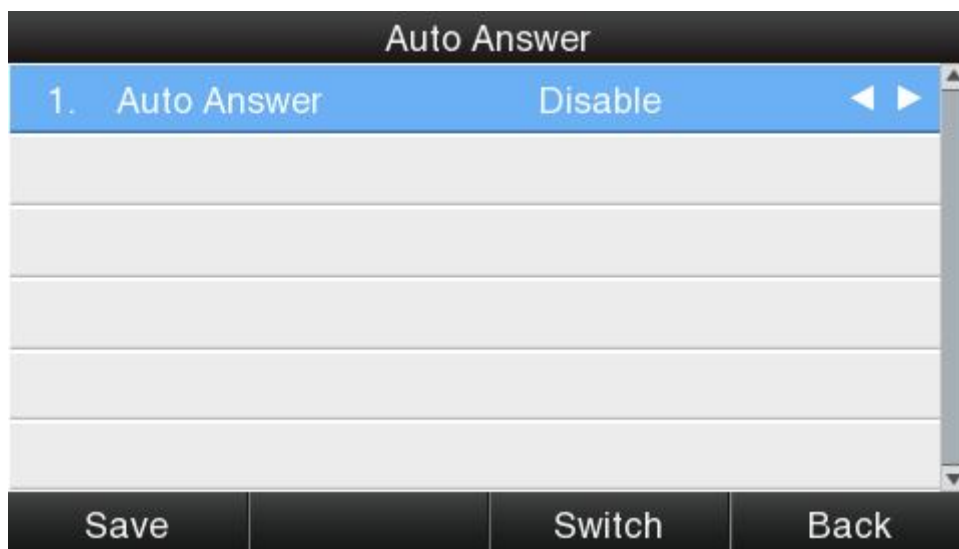

The Icon  will be indicated once "Auto Answer" is available.

Setup "Auto Answer" via Web: "**Phone**"→ "**Feature**"→ "**General information**"→ "**Auto Answer**"

## Programmable Keys

The programmable keys include Line keys, Memory keys (aside the BLF LCD Display). Programmable feature keys and Soft key on Standby UI.

Press the programmable key for 2 seconds, you're able to modify the feature of each programmable key.

All programmable keys has been classified as "N/A", "Line Key", "BLF", "Key event", "Speed dial", "Intercom"

And the "Key Event" has been classified as "Conference", "Hold", "DND", "Redial", " Call return", "Pickup", "Call Park", "DTMF", "Directory".

Comment:

### **N/A**



N/A means this key is not permitted to be set as a programmable key.

### **Line key**

Display the account information, press it for making a call, answering incoming calls, call hold and resume.





| Line Key1       |               |      |
|-----------------|---------------|------|
| 1. Type         | Line Key      |      |
| 2. Account ID   | Account 1     |      |
| 3. Account name | 6061          |      |
| 4. SIP Server   | 192.168.1.123 |      |
|                 |               |      |
|                 |               |      |
|                 |               |      |
| Save            | Switch        | Back |

| Item                | Description   |
|---------------------|---|
| <b>Account ID</b>   | To display the account ID, press the soft key " <b>Switch</b> " or  、  to modify, the optional value is Account 1 to 4. |
| <b>Account name</b> | Display the account name of each account ID, non-modifiable.  |
| <b>SIP Server</b>   | The SIP server of each Account ID, non-modifiable. If not set any value for some account ID, the account name will be null.   |

## BLF

Indicate the status of monitored account. Once set the BLF key with Pickup feature, user is able to answer the incoming call to the monitored account by pressing the corresponding BLF key. If the monitored account is idle, press the corresponding BLF key for speed dial.



| Item              | Description   |
|-------------------|---|
| <b>Account ID</b> | To display the account ID, press the soft key " <b>Switch</b> " or  、  to modify, the optional value is Account 1 to 4. |
| <b>Label</b>      | To identify this key on LED, for example "BLF"  |
| <b>Value</b>      | The phone number will be monitored by this key. For example, if user want to monitor the phone number (6070), please set "6070" here.   |
| <b>Extension</b>  | This code must be set for pickup, and this code provide by Server. If the code is not matched by Server, the feature of pickup will not work.   |

## Conference

The 3-way conference will be setup by pressing the key "Conf" while on calling. For more info, please refer to [Chapter 3.8](#).

The configuration item **Label** is a name to identify the key on LED, can be set as "conference".

## Hold

The same feature as the key . For more info, please refer to [Chapter 3.5](#).

The configuration item **Label** is a name to identify the key on LED, can be set as "hold".

## DND

Press this key will switch on or switch off the feature of "DND".

The configuration item **Label** is a name to identify the key on LED, can be set as "DND".

## Redial

The same feature as the key .

The configuration item **Label** is a name to identify the key on LED, can be set as "redial".

## Call return



Automatically dial the latest phone number in history.

The configuration item **Label** is a name to identify the key on LED, can be set as "return".

## Call Pickup

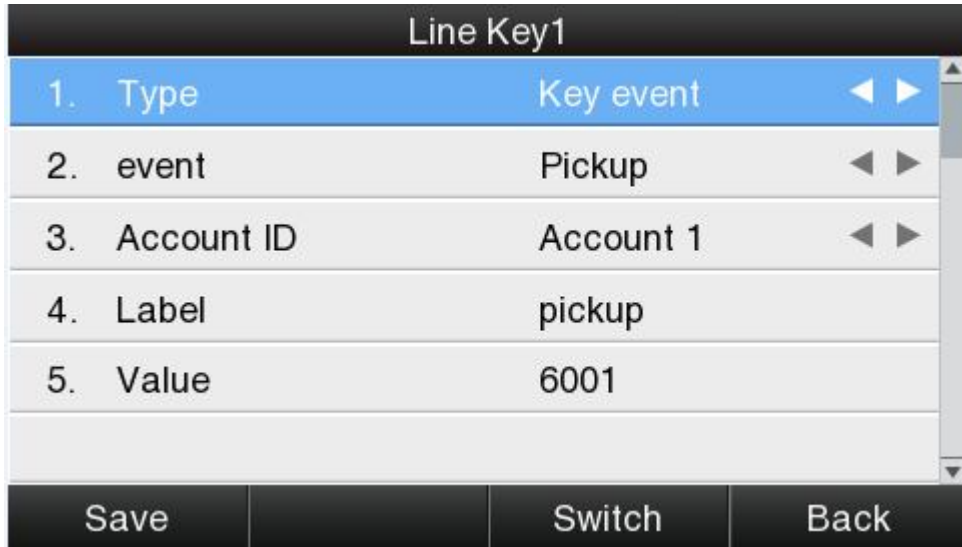
Press this key to pick up if new incoming call to the monitored phone number.



| Item              | Description  |
|-------------------|--|
| <b>Account ID</b> | To display the account ID, press the soft key "Switch" or  ,  to modify, the optional value is Account 1 to 4. |
| <b>Label</b>      | To identify this key on LED, for example "pickup"  |
| <b>Value</b>      | The phone number monitored for pickup  |

Reminding: This code must be set for pickup, and this code can be set via Web only.

Set the Pickup code as follow:



Set the pickup code for one single Account: **Account→Advanced→Select an account to be configured→Directed Call Pickup Code.**

Set the pickup code for all Accounts: **Phone→Features→Call Pickup→Direct Call Pickup、Direct Call Pickup Code (Direct Call Pickup should be set as Enable) .**

### Call Park

Press this key while on calling, the phone will dial the specified phone number, user will receive a code on the phone prompt, and then press the soft key "Transfer", the current calling will be parked successfully. At this moment, user is able to continue the parked calling with any other phones which registered on the same SIP server by dialing the code which user have received.



| Item              | Description  |
|-------------------|--|
| <b>Account ID</b> | To specify an account to park the call, press the soft key " <b>Switch</b> " or  、  to modify, the optional value is Account 1 to 4. |
| <b>Label</b>      | To identify this key on LED, for example as "park".  |
| <b>Value</b>      | The code for pickup the parked call and it is provided by SIP server.  |

**DTMF**

Press this key while on calling, the phone will send the configured "**Value**" automatically.





| Item         | Description                                      |
|--------------|--|
| <b>Label</b> | To identify this key on LED, for example "DTMF". |
| <b>Value</b> | The value sent to remote end while on calling.   |

## Directory



Press this key to access Directory.

The configuration item **Label** is a name to identify the key on LED, can be set as "phonebook".

## Speed Dial

Press this key while standby state, the specified target phone number will be dial from the specified account.





| Item              | Description   |
|-------------------|---|
| <b>Account ID</b> | To display the account ID, press the soft key " <b>Switch</b> " or  、  to modify, the optional value is Account 1 to 4. |
| <b>Label</b>      | To identify this key on LED, for example "speed dial"   |
| <b>Value</b>      | The target phone number for speed dial  |

## Intercom

Press this key when the phone is idle, the phone will dial the specified "Value", and the remote end will answer the call automatically.

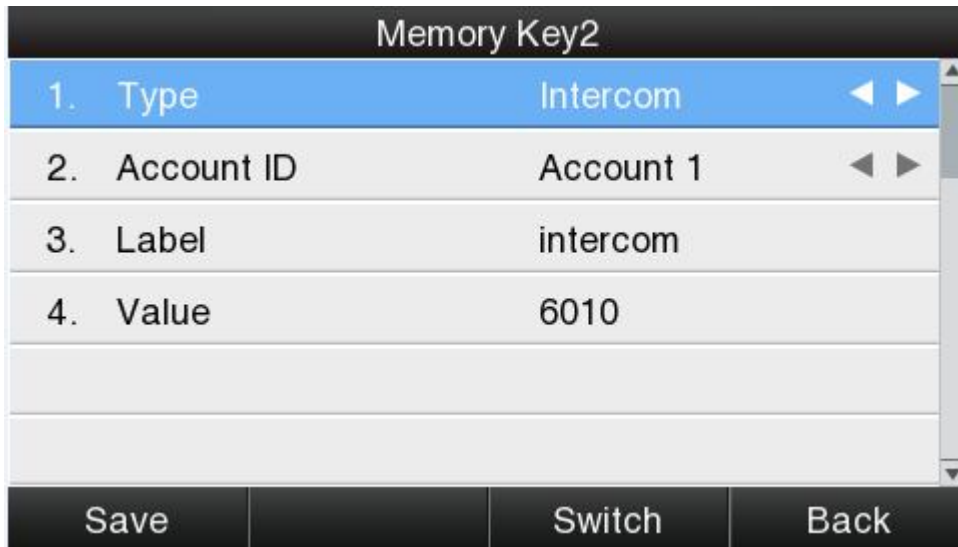
Note: This feature is supported by specified servers only.



| Item              | Description   |
|-------------------|---|
| <b>Account ID</b> | To display the account ID, press the soft key " <b>Switch</b> " or  ,  to modify, the optional value is Account 1 to 4. |
| <b>Label</b>      | To identify this key on LED, for example "intercom".  |
| <b>Value</b>      | The target phone number for Intercom  |

The programmable key configured via web included Memory Key, Line Key, Programmable Feature Key, and Feature key of expansion module.

| atcom   |           |              |       |             |           |           |
|---|-----------|--------------|-------|-------------|-----------|-----------|
| Basic Account Network <b>DSS Key</b> Phone Contacts |           |              |       |             |           |           |
| Memory Key  | Key       | Type         | Value | Label       | Account   | Extension |
| Line Key  | DSS Key1  | N/A          |       |             | Auto      |           |
| Programmable Key                                    | DSS Key2  | Line         |       |             | Account 1 |           |
|   | DSS Key3  | Speed Dial   | 6050  | speed dial  | Account 1 |           |
| EXT Key   | DSS Key4  | BLF          | 6049  | BLF         | Account 1 | *8        |
|   | DSS Key5  | Direct Picku | 6048  | call pickup | Account 1 |           |
|   | DSS Key6  | Call Park    | 700   | call park   | Account 1 |           |
|   | DSS Key7  | Intercom     | 6051  | intercom    | Account 1 |           |
|   | DSS Key8  | DTMF         | 6750# | DTMF        | Auto      |           |
|   | DSS Key9  | Conference   |       | conference  | Auto      |           |
|   | DSS Key10 | Hold         |       | hold        | Auto      |           |
|   | DSS Key11 | DND          |       | DND         | Auto      |           |
|   | DSS Key12 | Redial       |       | redial      | Auto      |           |
|   | DSS Key13 | Directory    |       | directory   | Auto      |           |
|   | DSS Key14 | Call Return  |       | call return | Auto      |           |

## Key as Send

The key "Key as Send" has the same function as the soft key "Dial".

Reminding: This key is not available while pre-dial. It's the only way to press the soft key "Dial" or pickup the handset to finish pre-dial.

The default value is "#", and it could be set as "\*". If set the value as "disable", it means the function "Key as Send" is forbidden.

Set "Key as Send" via web : **Phone**→**Features**→**General Information**→**Key As Send**.

## Hotline

Once "Hotline" has been set, the phone will automatically dial the hotline via the 1st available line if the phone stay in the standby status exceed the specified waiting time and there is no input (or input something and then all deleted).



| Item                   | Description  |
|------------------------|--|
| <b>Hotline</b>         | Set up the hotline number, the value is null by default.         |
| <b>Hotline timeout</b> | Set up the timeout for hotline activation, 4 seconds by default. |

Set hotline via web: **Phone**→**Features**→**General Information**→**Hotline**.

Set Hotline Time-out(secs) via web: **Phone**→**Features**→**General Information**→**Hotline Time-out(secs)**.





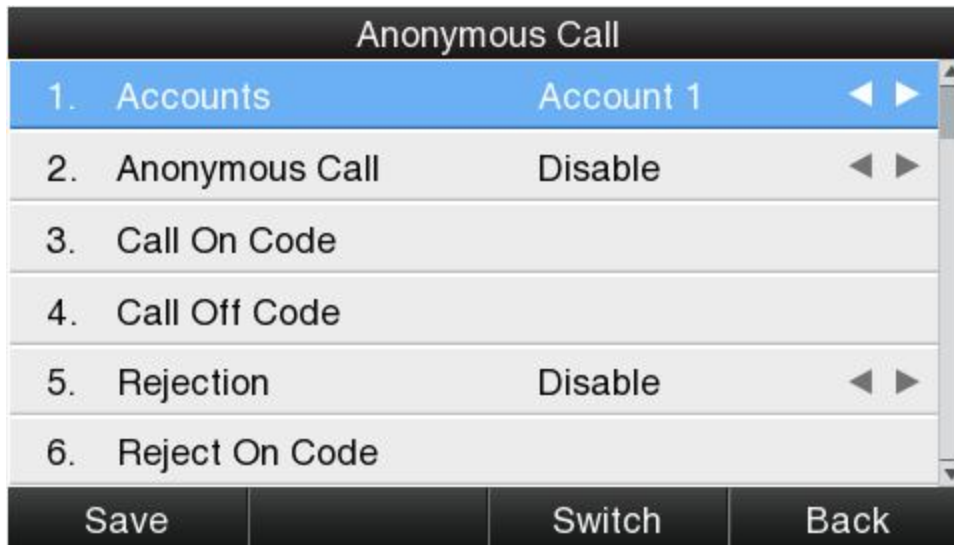

## Anonymous Call

This function includes making anonymous calls and blocking all anonymous calls.

If switch on the feature "Anonymous call", all outgoing calls will be displayed as anonymous call in the remote end.

If switch on the feature "Rejection", all incoming anonymous calls will be blocked automatically.



| Item                   | Operation  | Description   |
|------------------------|--|---|
| <b>Accounts</b>        | press the soft key " <b>Switch</b> " or  、  to modify,     | Select the Account for anonymous call.  |
| <b>Anonymous Call</b>  | press the soft key " <b>Switch</b> " or  、  to modify, | Switch on/off the feature of making anonymous calls.  |
| <b>Call On Code</b>    | The Number key, "*"key, and "#"are permitted to be input.  | Set the feature code to turning on anonymous call, the phone enables anonymous call by sending the feature code to the server                     |
| <b>Call Off Code</b>   | The Number key, "*"key, and "#"are permitted to be input.  | Set the feature code to turning off anonymous call, the phone disables anonymous call by sending the feature code to the server                   |
| <b>Rejection</b>       | press the soft key " <b>Switch</b> " or  、  to modify  | Switch on/off the feature of blocking anonymous calls.  |
| <b>Reject On Code</b>  | The Number key, "*"key, and "#"are permitted to be input.  | Set the feature code to turning on anonymous call rejection, the phone enables anonymous call rejection by sending the feature code to the server |
| <b>Reject Off Code</b> | The Number key, "*"key, and "#"are permitted to be input.  | Set the feature code to turning off anonymous call rejection, the phone disables anonymous call   |

|  |  |   |
|--|--|---|
|  |  | rejection by sending the feature code to the server |
|--|--|---|

Set Anonymous Call via web: **Account**→**Basic**→**Select the Account**→**Anonymous Call**.

Set Anonymous Call Rejection via web: **Account**→**Basic**→**Select the Account**→**Anonymous Call Rejection**.

### 4.3.3、Directory

The content of Directory includes local phonebook and blacklist. Enter Directory as follow,

1. Press the soft key "Directory" when the phone is standby

2. Press the navigation key 

3. Press the menu key , and then select "Directory"

Configure the "Directory" via Web:

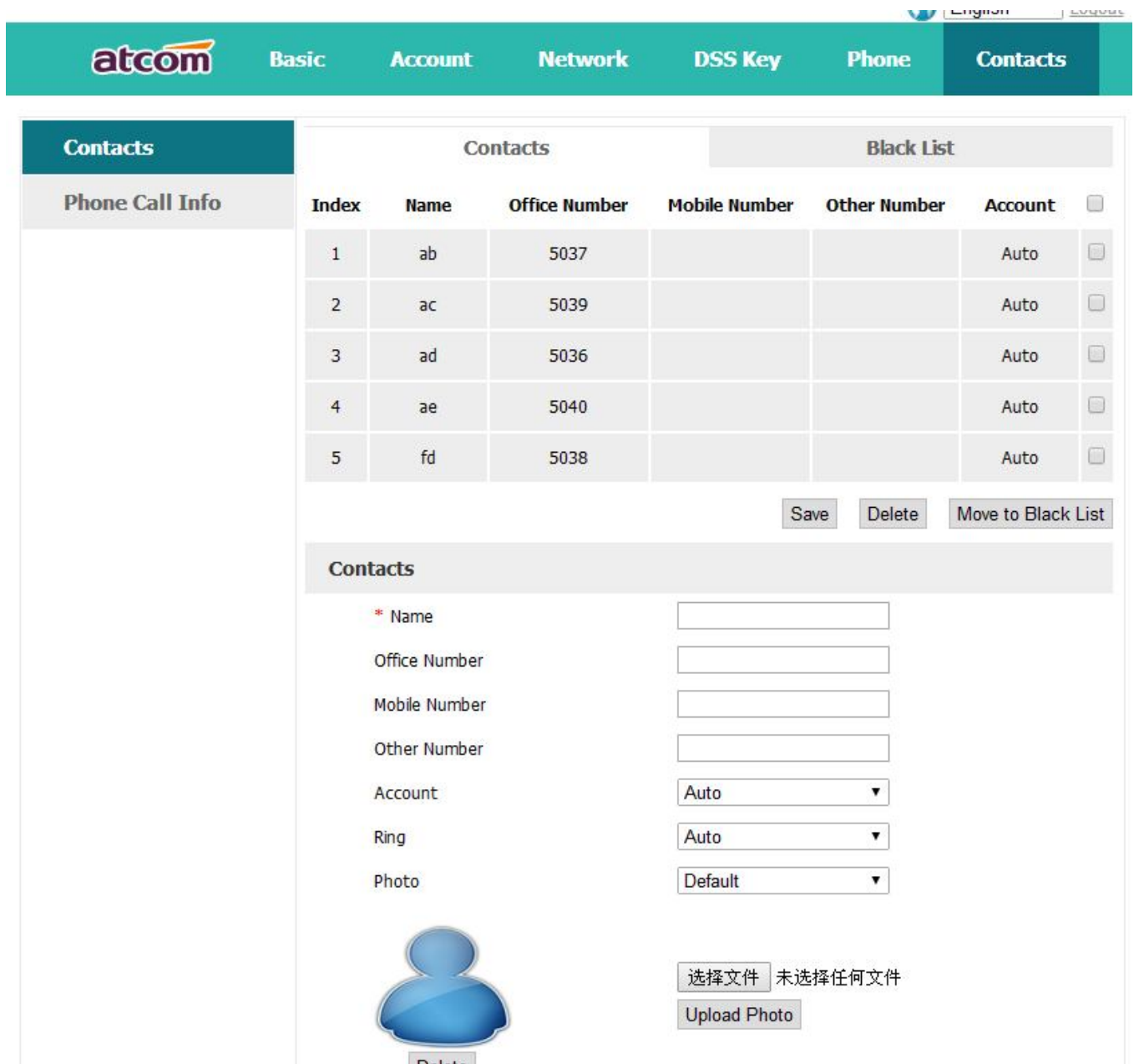

| Contacts |      |               |               |              |         | Black List               |
|----------|------|---------------|---------------|--------------|---------|--------------------------|
| Index    | Name | Office Number | Mobile Number | Other Number | Account | <input type="checkbox"/> |
| 1        | ab   | 5037          |               |              | Auto    | <input type="checkbox"/> |
| 2        | ac   | 5039          |               |              | Auto    | <input type="checkbox"/> |
| 3        | ad   | 5036          |               |              | Auto    | <input type="checkbox"/> |
| 4        | ae   | 5040          |               |              | Auto    | <input type="checkbox"/> |
| 5        | fd   | 5038          |               |              | Auto    | <input type="checkbox"/> |

Save Delete Move to Black List

**Contacts**

\* Name

Office Number

Mobile Number

Other Number

Account

Ring

Photo

  未选择任何文件

All operations on Directory via Web will be not active until click "Save". When too much item existed in the Directory, it will be an easy way to search by keyword about name, Office Number, Mobile Number or other Number. The exactly matched item will be listed, otherwise you will be prompted "Not find the specified contact".

There is a newer feature when you edit connect or blacklist, it could be upload defined photo, it will be display on the directory and RainbowET

## Local phonebook

Name and phone number are permitted to be saved into the local phonebook, and up to 400 items. It's able to add new contact, edit or delete exist contact or dial, also move the item to blacklist.

### Make calls from directory

Path to set on the phone:  → **Directory** → **Local Contacts** → **Select the record** → **Dial**.

If only one phone number saved with the selected contact person, the phone number will be dialed while calling the contact person.



| Local Contacts   |      |
|--|------|
|  damon    | 6007 |
|  jassica | 222  |
|  kobe   | 333  |
|  rachel | 444  |
|  stan   |      |

Dial      Add      Option      Back

If multiple phone numbers saved with the selected contact person, user must select one of the phone numbers for dialing while calling the contact person.



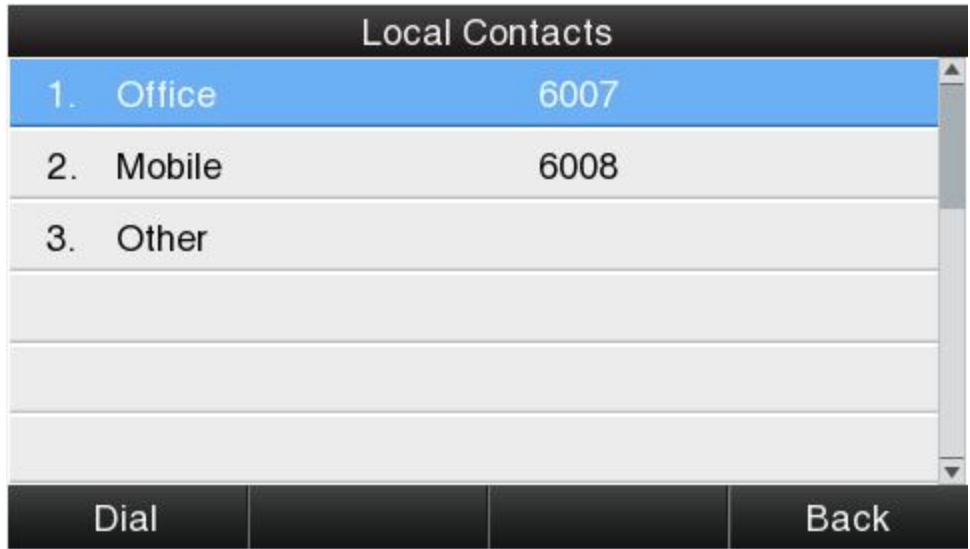





Add new contact

Path to add new contact on the phone: Press  → **Directory** → **Local Contacts** → **Add**.



| Item          | Operation   | Description   |
|---------------|---|---|
| <b>Name</b>   | Input by number keys, "*" or "#" key, change the input-method via pressing the soft key "abc" | It's used to identify different phone numbers. Any reduplicated names are not permitted in the directory. |
| <b>Office</b> | Input by number keys,   | You can save three numbers at most.   |

|                |  |  |
|----------------|--|--|
| <b>Mobile</b>  | "*"or "#"key, change the input-method via pressing the soft key "abc"  | While calling a contact person in directory, the phone will redirect to the page that to select one number to dial when multiple numbers are saved for one contact record  |
| <b>Other</b>   |  |  |
| <b>Account</b> | Press the key  ,  or the soft key "Switch" to modify the account ID. | It's used to bundle each item with the corresponding account, and the optional value is "Auto" or "Account 1"to "Account 4". "Auto" means the 1 <sup>st</sup> available account will be selected.  |
| <b>Ring</b>    | Press the key  ,  or the soft key "Switch" to modify the account ID. | It's used to bundle each item with the corresponding ringtone, and the optional value is "Auto" or "Ringtone 1"to "Ringtone 10". "Auto" means the default ringtone will be played if new incoming call happened, otherwise the selected ringtone will be played. |
| <b>Photo</b>   | Only for preview. It's available for modification via Web only.  | To identify a contact item by a specified image.   |

Add new contact via web: **Contacts** → **Contacts** → **Input messages** → **Add** → **Save**.

Edit the contact

User must re-edit the contact item while updating one item of local phonebook.

Path to edit the contact on the phone: Press  → **Directory** → **Local Contacts** → **Select the item to edit** → **Option** → **Edit** → **OK**.



Edit the contact item via Web: **Contacts**→**Contacts**→**click on the item to edit**→**modify Option**→**Click "Edit"**→**Click "Save"**.

Delete the contact

Path to delete the contact on the phone: Press  → **Directory**→**Local Contacts**→**Select the item to delete**→**Option**→**Delete**→**OK**.

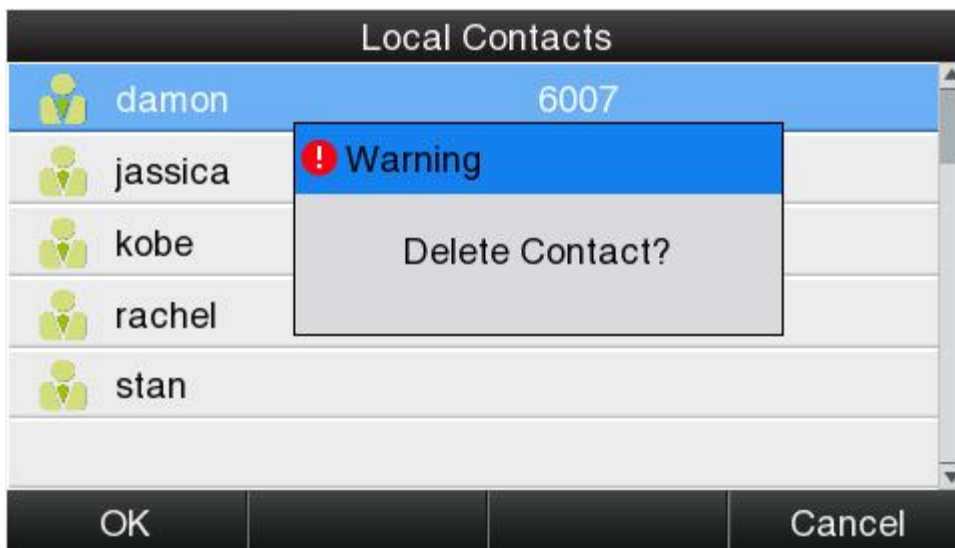

Press the soft key **"Cancel"** at the Warning UI to stop deleting.

Delete the contact item via web: **Contacts**→ **Contacts**→**Select the item to delete**→**Click on "Delete"**→**Click on "Save"**.

Move to blacklist

Path to move to blacklist on the phone: Press  → **Directory** → **Local Contacts** → **Select the item to move** → **Option** → **Move to Blacklist** → **OK** → **OK**.

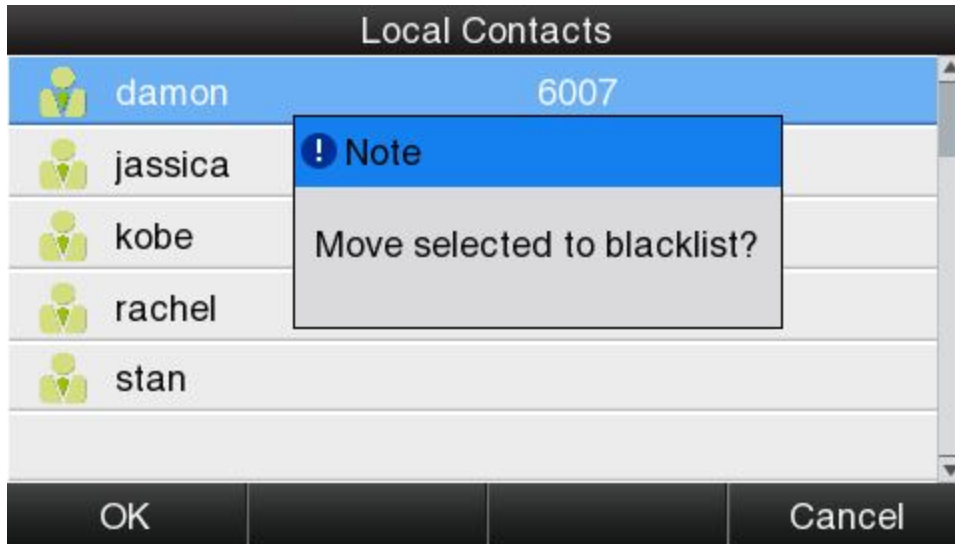

Press the soft key **“Cancel”** at the Warning UI to stop this operation.

Move the contact item to blacklist via web : **Contacts** → **Contacts** → **Select the item to move to blacklist** → **Click on “Move to black List”** → **Click on “Save”** .

Blacklist



The purpose of blacklist’s feature is to block the phone number inside blacklist to call the host phone number, but it’s available for the hosted phone number to call any phone number in the black list.

The most operation of blacklist is the same as local phonebook except for the feature “Move to Contacts”, it means moving an item of blacklist to local phonebook to resume the phone number to dial the host phone number normally.

#### 4.3.4、 History

It includes the dialed, answered, missed and transferred items, maximum 400 items.

User is able to review or delete any item of the history on the phone. And enter “History” in below ways:

1. Press the key 
2. Press the key , then select "History"
3. Press the soft key "History" while phone is under standby status

When any operations above is done, details info of all recent history will be listed on LCD display, include the type of each item, the name of contact person, date and time.

Also, user is able to check the detail info of call history via Web, but only review operation is allowed while accessing via web.

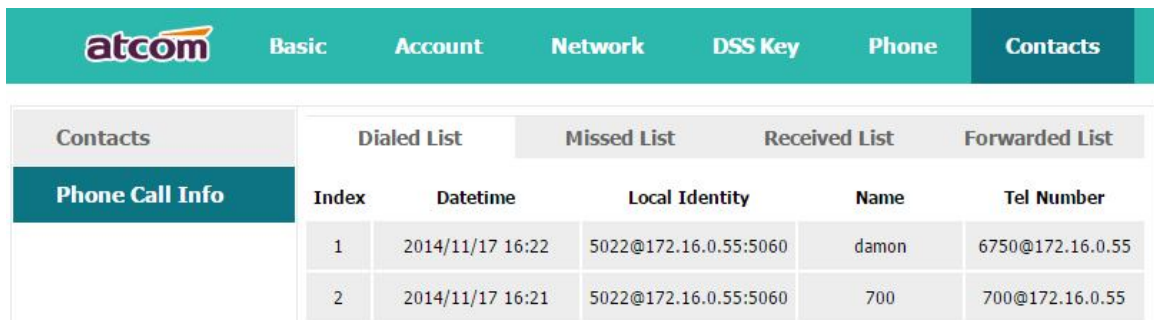

| Contacts               | Dialed List  | Missed List      | Received List         | Forwarded List |                   |
|------------------------|--------------|------------------|-----------------------|----------------|-------------------|
| <b>Phone Call Info</b> | <b>Index</b> | <b>Datetime</b>  | <b>Local Identity</b> | <b>Name</b>    | <b>Tel Number</b> |
|                        | 1            | 2014/11/17 16:22 | 5022@172.16.0.55:5060 | damon          | 6750@172.16.0.55  |
|                        | 2            | 2014/11/17 16:21 | 5022@172.16.0.55:5060 | 700            | 700@172.16.0.55   |

### Make calls from history

Path to make calls from history on the phone: **Enter history UI→Select the item to dial→Dial.**



| Call List   |       | 1/5                  |
|---|-------|----------------------|
|  | 6048  | Fri. Nov. 14 11:55am |
|  | 6028  | Fri. Nov. 14 11:54am |
|  | 6030  | Fri. Nov. 14 11:54am |
|  | damon | Fri. Nov. 14 11:53am |
|  | 700   | Fri. Nov. 14 11:53am |
|  | damon | Fri. Nov. 14 11:53am |

Dial      Delete      Option      Back

Delete one item from history

Path to delete one item from history on the phone: **Enter history UI→Select the item to delete→Delete.**

Check the details of history

Path to check the detail history on the phone: **Enter history UI→Select the item to check →Option→Detail→Press  or "OK".**

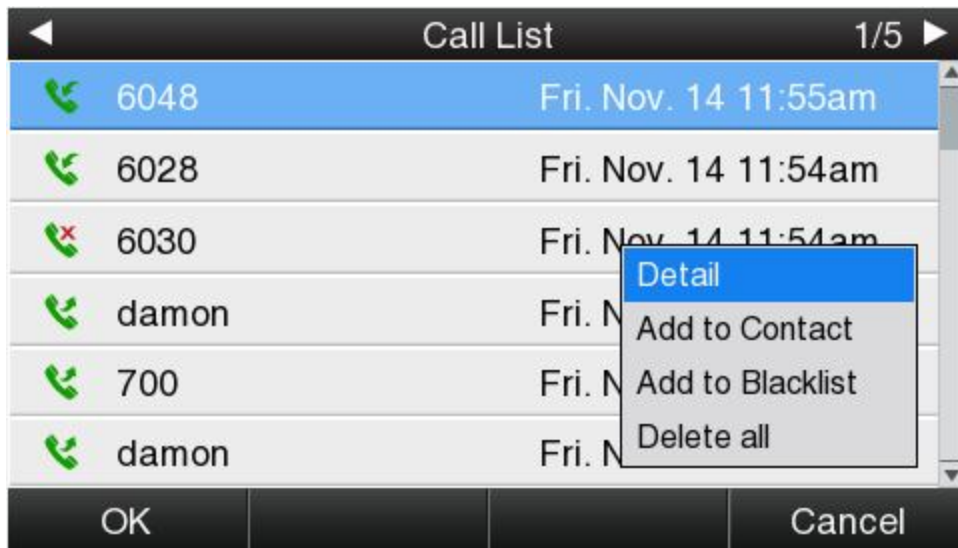

Add to Contact



1. **Enter "Call History"→Select the target item→Option→add to Contact→Press the key  or soft key "Confirm".**

At this moment an "edit" page will be popped up.

| Add to Contact |         |            |             |
|----------------|---------|------------|-------------|
| 1.             | Name    | 6048       |             |
| 2.             | Office  | 6048       | ◀ ▶         |
| 3.             | Mobile  | Old Number | ◀ ▶         |
| 4.             | Other   | Old Number | ◀ ▶         |
| 5.             | Account | Auto       | ◀ ▶         |
| 6.             | Ring    | Auto       | ◀ ▶         |
| Save           |         | abc        | Delete Back |

The item of "Office", "Mobile" and "Other" are able to be switched over between "Old Number" and current number. If the being operated item had been saved already in the directory, "Old Number" will be the previous value, otherwise "Old Number" will be null. The UI page of "Add to Blacklist" is the same as above.

2. **Modify the contact name, phone number and ringtone.**

3. **Press the key  or soft key "Saved" to save the modification, press the key  or soft key "Cancel" to Cancel the modification.**

Add to Blacklist

For more info about this operation, please refer to [Add to Contact](#).

Delete all History's records

Path to delete all history's records on the phone: **Enter History UI**→**Option**→**Delete all**→

**Press  or "OK".**

#### 4.3.5、 Message

User will benefit from the feature of voicemail when they're not available to answer an incoming call or missed some incoming calls. However this feature must be supported by Server. Voicemail must be set up before using it.

Set the voicemail via Web: **Account**→**Basic**→**Select an account to configure**→**Voice Mail**.



Sometimes the voicemail push can't be reached in time, because the configuration problem with Server, you must configure some related parameter via Web to make the phone automatically send its request to Server for getting voicemail info.

Set "Subscribe for MWI" via web: **Account**→**Advanced**→**Subscribe for MWI**.

Set "MWI Subscription Period(secs)" via web: **Account**→**Advanced**→**MWI Subscription Period(secs)**.

## Set Voice Mail

There is 3 different methods to set up the voicemail,



1. Press the key  after factory set
2. Press the key  for a while
3. Press the key  →Select "Message"→Setup Voicemail





Check the voicemail

User is able to check voicemail in below ways:

1. **Setup voicemail number**→**Press the key** 
2. **Press the key** →**Select "Message"→"New Voicemail"**

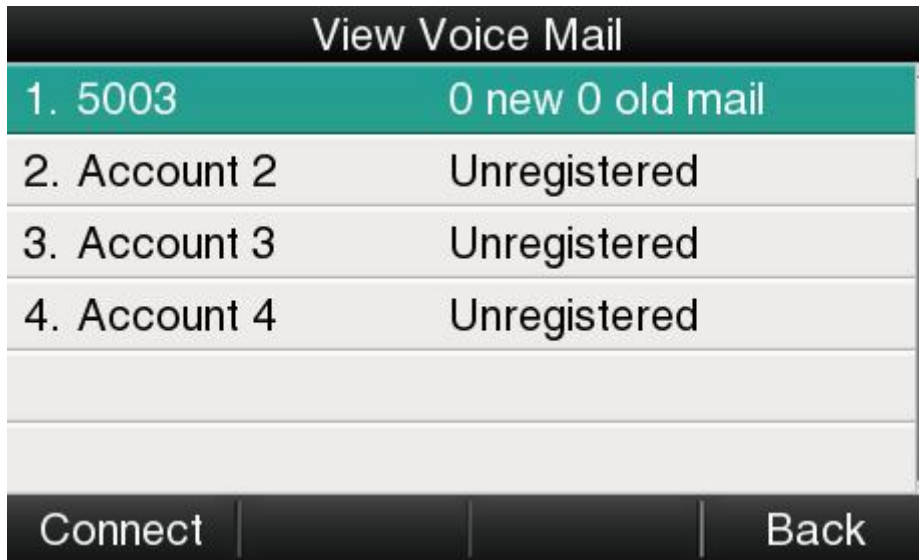

Select the account with "N new N old mail", and press the soft key "Connect", the corresponding voicemail will be connected.

Select the account with "Unregistered", and press the soft key "Connect", the setting page of Voicemail will be popped up.

#### 4.3.6、 Settings

Basic settings and Advanced settings will be introduces in this part,

Basic settings:

- [Language](#)
- [Time & Date](#)
- [Time & Date Format](#)
- [Ringtones](#)
- [Headset Memory Mode](#)

Advanced settings:

- [Accounts](#)
- [Set Password](#)
- [Network](#)
- [Reset to factory](#)

Basic Settings

Language

R3(s) supports multiple language, to modify the language, please press the key  →

**Setting** → **Basic setting** → **Language** → **Select the target language and press the soft key "Save"**.



Set language via web: There is a drop-down box at the top left corner of webpage, choice one kind of language and click, the language will take effect immediately.







## Time &Date

Time & Date will be displayed at the standby page of R3(s), and these info will be related with all process of IP phone. "Time & Date" can be gained by NTP Server automatically or set manually.

### NTP Setting

Path to set on the phone: Press  → **Settings** → **Basic Settings** → **Time & Date** → **NTP Settings**.



| Item                        | Operation   | Description   |
|-----------------------------|---|---|
| <b>Time Zone</b>            | Press the key  ,  or soft key " <b>Switch</b> " to modify it. | Select the correct Time Zone for the IP phone.  |
| <b>NTP Server</b>           | Key in the IP address of domain name by the number keys, "*", "#"   | Specify the NTP Server  |
| <b>Secondary NTP Server</b> | Key in the IP address of domain name by the number keys, "*", "#"   | Specify the secondary NTP Server  |
| <b>Daylight-Saving Time</b> | Press the key  ,  or soft                                     | Optional: " <b>Off</b> ", " <b>Auto</b> " or " <b>Manual</b> ". And " <b>Manual</b> " mean user must set this |

|  |                           |          |
|--|---------------------------|----------|
|  | key"Switch" to modify it. | via web. |
|--|---------------------------|----------|

Set NTP via Web: **Phone**→**Preference**.

|                       |  |   |
|-----------------------|--|---|
| Time Zone             | +8 China(Beijing) ▼  | i |
| Primary NTP Server    | pool.ntp.org   |   |
| Secondary NTP Server  | time.windows.com   |   |
| Update Interval(secs) | 1000   | i |
| daylight              | Disable ▼  | i |
| Fixed Type            | <input checked="" type="radio"/> By Date <input type="radio"/> By Week |   |
| Start Month           | January ▼  |   |
| Start Date            | 1  |   |
| Start Hour of Day     | 0  |   |
| Start Day of Week     | Sunday ▼   |   |
| Start Week of Month   | First In Month ▼   |   |
| Stop Month            | January ▼  |   |
| Stop Date             | 1  |   |
| Stop Hour of Day      | 0  |   |
| Stop Day of Week      | Sunday ▼   |   |
| Stop Week of Month    | First In Month ▼   |   |
| Offset(minutes)       | 0  |   |

| Item                         | Operation                     | Description   |
|------------------------------|-------------------------------|---|
| <b>Time Zone</b>             | Click drop-down box to select | Set a time zone matches condition                               |
| <b>Primary NTP Server</b>    | Manual input                  | The primary NTP server that provide time and date               |
| <b>Secondary NTP Server</b>  | Manual input                  | The secondary NTP server that provide time and date             |
| <b>Update Interval(secs)</b> | Manual input                  | The interval that the phone gains time and date from NTP server |
| <b>Daylight</b>              | Click drop-down box to        | A switch to control the status that                             |

|                            |                               |  |
|----------------------------|-------------------------------|--|
|                            | select                        | whether to enable the daylight or not                          |
| <b>Fixed Type</b>          | Radio content                 | Daylight fixed type, only the specified items are configurable |
| <b>Start Month</b>         | Click drop-down box to select | The month that the daylight rule begins taking effect          |
| <b>Start Date</b>          | Manual input                  | The day that the daylight rule begins taking effect            |
| <b>Start Hour of Day</b>   | Manual input                  | The hour of day that the daylight rule begins taking effect    |
| <b>Start Day of Week</b>   | Click drop-down box to select | The day of week that the daylight rule begins taking effect    |
| <b>Start Week of Month</b> | Click drop-down box to select | The week of month that the daylight rule begins taking effect  |
| <b>Stop Month</b>          | Click drop-down box to select | The month that the daylight rule stops taking effect           |
| <b>Stop Date</b>           | Manual input                  | The day that the daylight rule stops taking effect             |
| <b>Stop Hour of Day</b>    | Manual input                  | The hour of day that the daylight rule stops taking effect     |
| <b>Stop Day of Week</b>    | Click drop-down box to select | The day of week that the daylight rule stops taking effect     |
| <b>Stop Week of Month</b>  | Click drop-down box to select | The week of month that the daylight rule stops taking effect   |
| <b>Offset(minutes)</b>     | Manual input                  | The offset time that daylight rule takes effect                |

## Manual Settings

Path to set on the phone: Press  → **Settings** → **Basic Settings** → **Time & Date** → **Manual Settings**.

| Manual Settings |      |
|-----------------|------|
| 1. Year         | 2014 |
| 2. Month        | 11   |
| 3. Day          | 15   |
| 4. Hour         | 11   |
| 5. Minute       | 23   |
| 6. Second       | 53   |
| Save            | 123  |
| Delete          | Back |

| Item          | Operation                                       | Description |
|---------------|---|-------------|
| <b>Year</b>   | Key in "Year" with the number key, "*"and "#"   | Date info   |
| <b>Month</b>  | Key in "Month" with the number key, "*"and "#"  |             |
| <b>Day</b>    | Key in "Day" with the number key, "*"and "#"    |             |
| <b>Hour</b>   | Key in "Hour" with the number key, "*"and "#"   | Time info   |
| <b>Minute</b> | Key in "Minute" with the number key, "*"and "#" |             |
| <b>Second</b> | Key in "Second" with the number key, "*"and "#" |             |

Set the Time & Date manually via web: **Phone**→**Preference**.

Manual Time  

Date

Time

| Item               | Operation                         | Description   |
|--------------------|-----------------------------------|---|
| <b>Manual Time</b> | Click the drop-down box to select | A switch to control the status whether to enable the manual time or not |

|             |  |                   |
|-------------|--|-------------------|
| <b>Date</b> | Manual input, click "Generated Date" to gains date from the computer | Set date manually |
| <b>Time</b> | Manual input, click "Generated Time" to gains time from the computer | Set time manually |

Time&Date Format

Path to set on the phone: Press  → **Settings** → **Basic Settings** → **Time & Date Format**.



| Item         | Optional   | Example of result |
|--------------|------------|-------------------|
| <b>Clock</b> | 12 hour    | 03:30pm           |
|              | 24 hour    | 15:30             |
| <b>Date</b>  | WWW MMM DD | Tuesday Oct.16    |
|              | DD-MMM-YY  | 16-Oct.-14        |
|              | YYYY-MM-DD | 2014-10-16        |
|              | DD/MM/YYYY | 16/10/2014        |
|              | MM/DD/YY   | 10/16/14          |

|  |             |                 |
|--|-------------|-----------------|
|  | DD MMM YYYY | 16,Oct.,2014    |
|  | WWW DD MMM  | Tuesday,16,Oct. |



Set the Time &Date Format via Web: **Phone**→**Preference**

## Ringtones

10 different ringtones have been provided by R3(s) for selection. Path to set on the phone:

Press the key  → **Settings** → **Basic Settings** → **Ringtones**.



For the selected ringtone, there is a dot inside the circle. Press the key  or  to select other ringtone for playing.

Set ringtones via Web: **Account**→**Basic**→**Ring tones**.

## Headset Memory Mode

Headset memory mode can be used to control the default device to make or answer calls. This function is disabled by default, which means the phone will communicate with others by hand-free when pre-dial or making calls from history or directory, and so is the situation that pressing "Answer" soft key to accept an incoming call. Once this function is enabled, the phone



will make or answer calls by headset. Long press  can change the status of the "Headset Memory Mode".

This function can be configured on the phone only: Press  → **Settings** → **Basic Settings** → **Headset Memory Mode**.

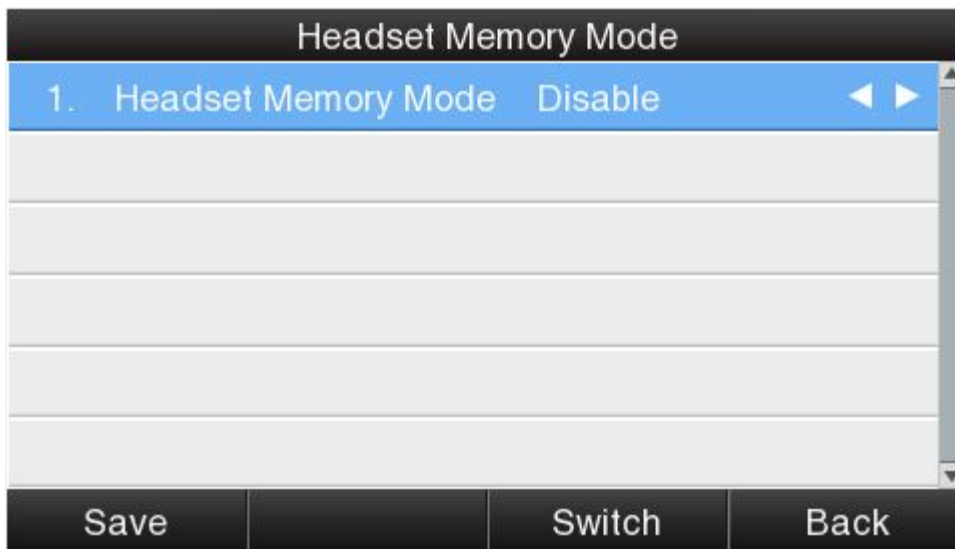

## Advanced Settings

Password will be requested while accessing the page of "Advanced Settings". This password is the same as the user's ("admin") to access.

## Accounts

Up to 4 accounts supported by R3(s), path to set the account info on phone: Press  → **Settings** → **Advanced Settings** → **Input password** → **Accounts**.



| Status                 | Description                             |
|------------------------|---|
| <b>Empty</b>           | The account has not been configured yet |
| <b>Registered</b>      | The account has been registered already |
| <b>Register Failed</b> | The account is register failed          |
| <b>Disabled</b>        | The account is disabled                 |

Select the account and press the soft key “**Enter**”to access the page of account setting.



| Item              | Description  |
|-------------------|--|
| <b>Activation</b> | The status of account, the default is“Enable”, if set this as “Disable”,the account will be forbidden. |

|                        |   |
|------------------------|---|
| <b>Lable</b>           | It will show on the phone, can skip this item   |
| <b>Display Name</b>    | Parameter that in the SIP, if the SIP Server is supportable, this name will show on the phone of callee |
| <b>Register Name</b>   | The register ID, supplied by SIP Server, can skip this item   |
| <b>User Name</b>       | Account ID  |
| <b>Password</b>        | Password for account  |
| <b>SIP Server</b>      | The address that accounts needed to register from   |
| <b>Outbound Status</b> | The status of Outbound Server, "off" by default   |
| <b>Outbound Proxy</b>  | IP address of Outbound Agency   |
| <b>Stun Status</b>     | The status of Stun Server, "off" by default   |
| <b>Stun Server</b>     | IP address of Stun Server   |

Configure account via web: **Account**→**Basic**

| Basic    | Account                      | Account 1                               |
|----------|------------------------------|---|
| Codecs   | Register Status              | Register failed                         |
| Advanced | Account Active               | Enable                                  |
|          | Label                        | <input type="text"/> <i>i</i>           |
|          | Display Name                 | <input type="text"/> <i>i</i>           |
|          | Register Name                | <input type="text"/> <i>i</i>           |
|          | * User Name                  | <input type="text"/> <i>i</i>           |
|          | Password                     | <input type="text"/> <i>i</i>           |
|          | * SIP Server                 | <input type="text"/> Port 5060 <i>i</i> |
|          | Enable Outbound Proxy Server | Disable <i>i</i>                        |
|          | Outbound Proxy Server        | <input type="text"/> Port 5060 <i>i</i> |
|          | Transport                    | UDP <i>i</i>                            |
|          | NAT Traversal                | Disable <i>i</i>                        |
|          | STUN Server                  | <input type="text"/> Port 3478 <i>i</i> |

### Set Password

The password for Advanced Settings also is used for Web access as the role "admin". Path to set password on phone: Press  → **Settings** → **Advanced Settings** → **Input password** → **Set Password**.

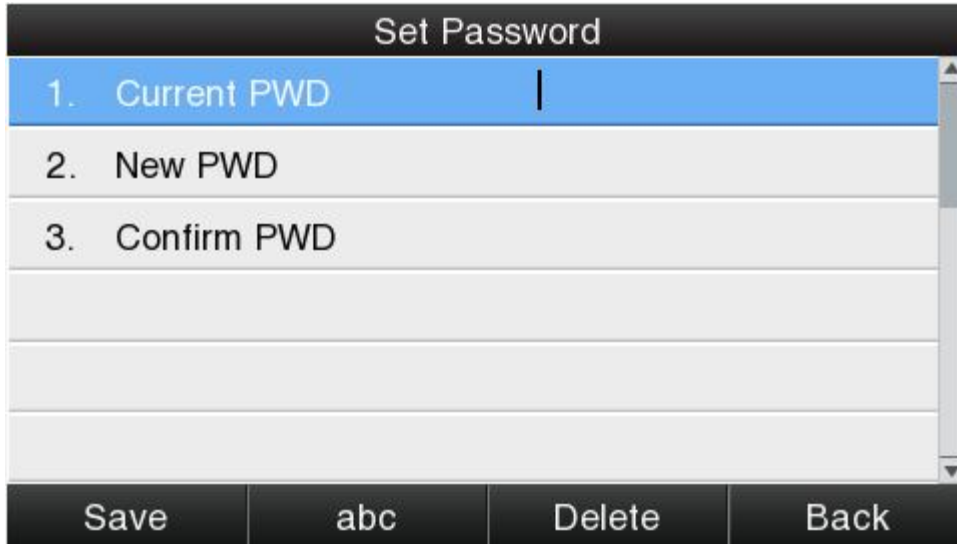

| Item               | Description  |
|--------------------|--|
| <b>Current PWD</b> | The current password for web access as the role of "admin", it's "admin" by default. |
| <b>New PWD</b>     | To set the new password, blank is acceptable.  |
| <b>Confirm PWD</b> | Input the new password again, to confirm the new password.                           |

Set password via Web: **Phone** → **Security**.

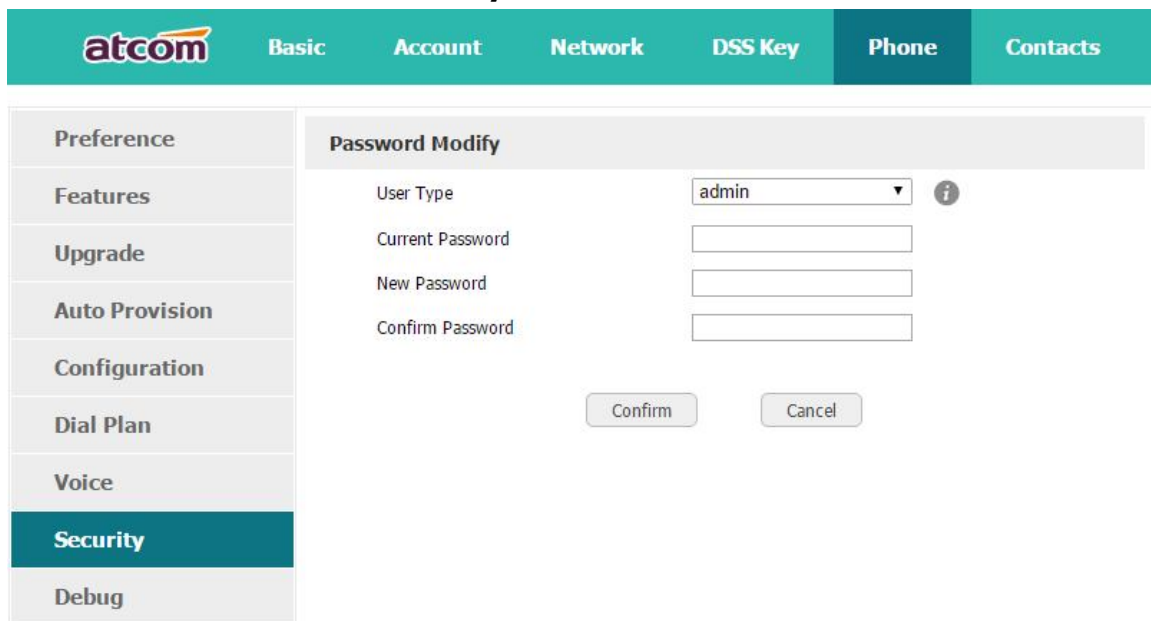

## Network

Path to set network parameters on phone: Press  → **Settings** → **Advanced Settings** → **Input the password** → **Network**.

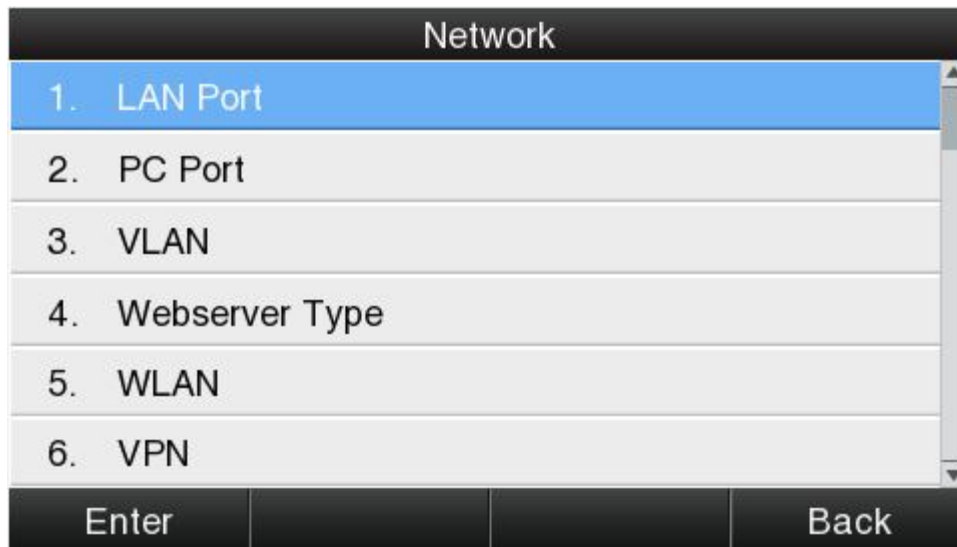

### LAN Port

Connect the phone with local network via LAN port, to gain IP address in 3 ways: DHCP, Static, PPPoE. Set the LAN port via Web: **Network** → **Basic**.

#### **DHCP**

The phone gains IP address via DHCP by default.

#### **STATIC IP**

If the phone gains IP address via Static IP, user must input the IP address info manually.

| STATIC IP          |               |        |      |
|--------------------|---------------|--------|------|
| 1. IP              | 192.168.1.149 |        |      |
| 2. Subnet Mask     | 255.255.255.0 |        |      |
| 3. Default Gateway | 192.168.1.1   |        |      |
| 4. Pri.DNS         | 8.8.8.8       |        |      |
| 5. Sec.DNS         | 4.4.4.4       |        |      |
|                    |               |        |      |
| Save               | 123           | Delete | Back |

### PPPoE

If the phone gains IP address via PPPoE, user must input username/password of PPPoE, and PPPoE server or ISP support will be requested in this way.

| PPPoE        |       |        |      |
|--------------|-------|--------|------|
| 1. User Name | pppoe |        |      |
| 2. Password  | ***** |        |      |
|              |       |        |      |
|              |       |        |      |
|              |       |        |      |
|              |       |        |      |
| Save         | 1aA   | Delete | Back |

### PC Port

Only bridge mode support by PC port.

### VLAN

The feature of VLAN must be supported by network switch, and by default this feature it's not activated on R3(s).

| VLAN                       |                |         |     |
|----------------------------|----------------|---------|-----|
| 1.                         | VLAN Status    | Disable | ◀ ▶ |
| 2.                         | LAN VID Number | 1       |     |
| 3.                         | LAN Priority   | 0       | ◀ ▶ |
| 4.                         | PC VID number  | 0       |     |
| 5.                         | PC Priority    | 1       | ◀ ▶ |
| Save      Switch      Back |                |         |     |

Set the VLAN via Web: **Network → Advanced → VLAN.**

### Webserver Type

Webserver type include HTTP and HTTPS, different access port will be required by different access type, user is able to confirm the port info at the webpage, HTTP & HTTPS are both permitted by default.

| Webserver Type             |                |            |     |
|----------------------------|----------------|------------|-----|
| 1.                         | Webserver Type | HTTP&HTTPS | ◀ ▶ |
| Save      Switch      Back |                |            |     |

Set Webserver type via Web: **Network → Advanced → WebServer → Type.**

### VPN

R3(s) support the feature of VPN, and this feature must be supported by VPN Server.

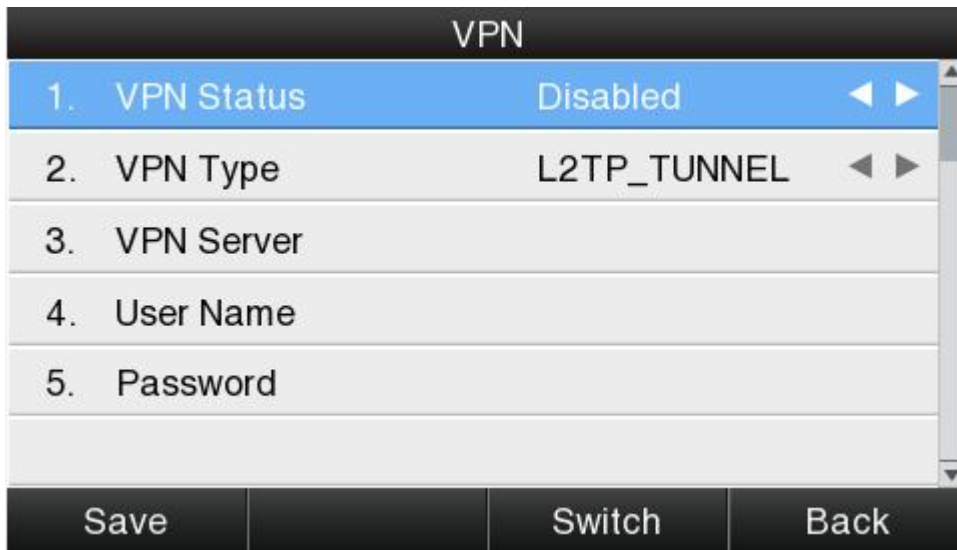

Set the VPN via Web: **Network** → **Advanced** → **VPN**.

Reset to factory

Once reset to factory, all parameter settings will back to the factory default value, and all configuration will be cleared, users must be careful on this.

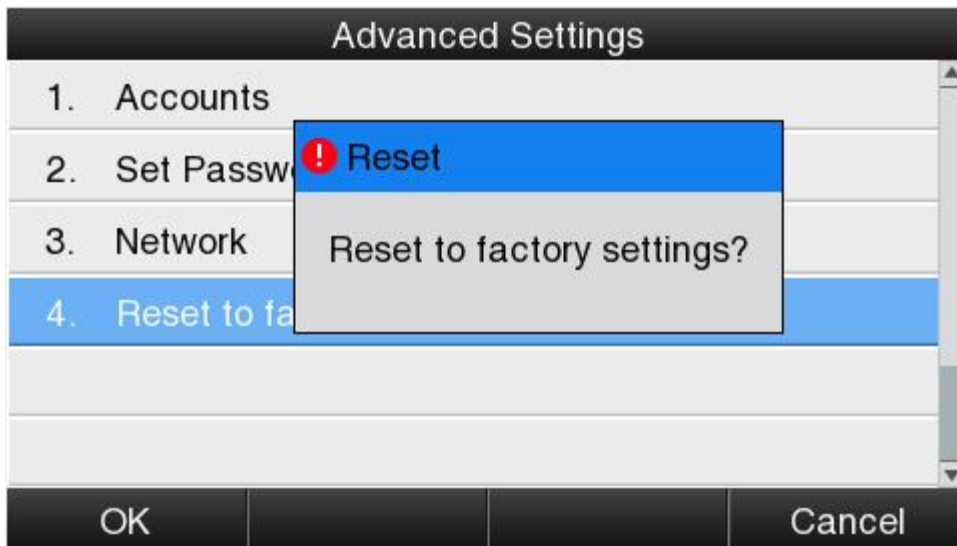

Reset to factory via Web: **Phone** → **Upgrade** → **Reset to Factory**.



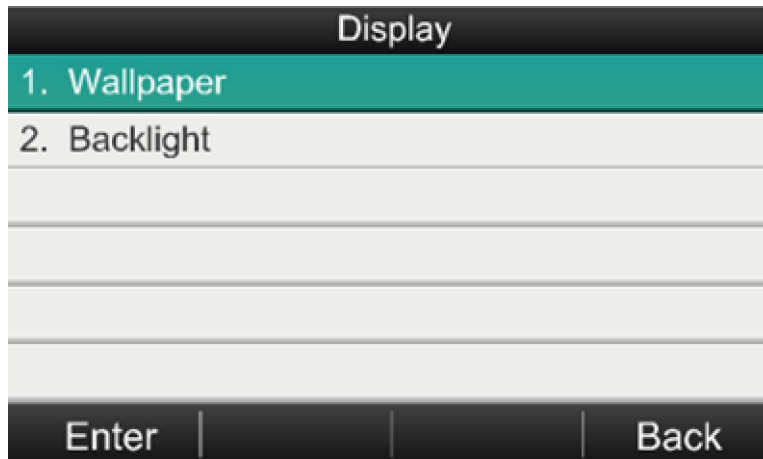

### 4.3.7、Display

For more convenient, users are able to change wallpaper and backlight of the main LCD display and the BLF LCD display.



#### Wallpaper

There are 5 different default pictures and you can upload defined pictures by via web, then press the soft key "**Switch**" or the key 、 for modification



Set up wallpaper via web : **Phone**→ **Preference** → **Wallpaper**

|                        |   |   |
|------------------------|---|---|
| Stop Week of Month     | <input type="text" value="First In Month"/>                                 |   |
| Offset(minutes)        | <input type="text" value="0"/>  | (-300~300)                                    |
| Manual Time            | <input type="text" value="Disable"/>  |   |
| Date                   | <input type="text"/>  | <input type="button" value="Generated Date"/> |
| Time                   | <input type="text"/>  | <input type="button" value="Generated Time"/> |
| Time Format            | <input type="text" value="12 Hour"/>  |   |
| Date Format            | <input type="text" value="WWW MMM DD"/>                                     |   |
| Backlight time         | <input type="text" value="1 min"/>  |   |
| Backlight Level        | <input type="text" value="6"/>  |   |
| Expand Backlight Level | <input type="text" value="6"/>  |   |
| Ring Tones             | <input type="text" value="Ring1.wav"/>                                      |   |
| <b>Wallpaper</b>       | <input type="text" value="5.jpg"/>  | <input type="button" value="Delete"/>         |
|                        | <input type="button" value="选择文件"/> 未选择任何文件                                 |   |
|                        | <input type="button" value="Upload"/> <input type="button" value="Cancel"/> |   |

## Backlight

Backlight is the brightness of LCD, also it has been defined as 9 different grades. The number "9" means the lightest.







To adjust the brightness of LCD expansion module, it must be connected with the hosted phone. Otherwise the host phone will indicated "No expansion module".

## 5、Advanced Feature

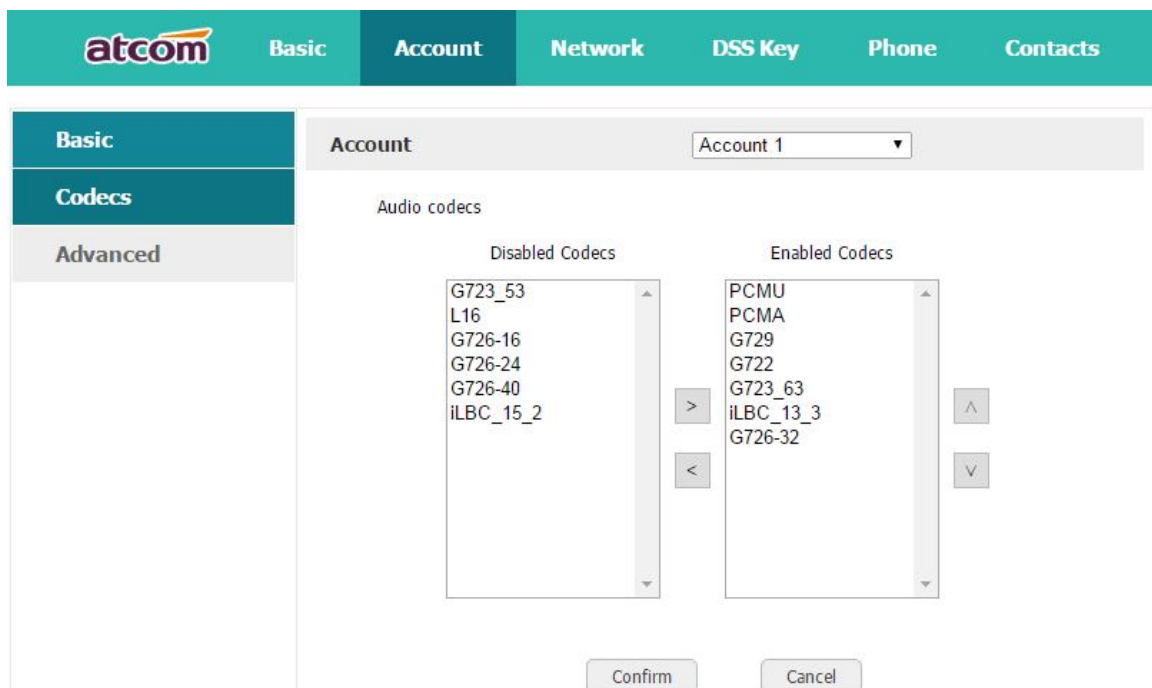
### 5.1、Codecs

R3(s) support multiple codecs, users can select the codes via Web.



 means to enable the item of "Disabled Codes",  means to disable the item of "EnabledCodes"; click the button  or  to sort all enabled codes, the top item has the highest priority.

Note: Multiple different items of G723, iLBC should not activated simultaneously.

### 5.2、Capture and Upgrading

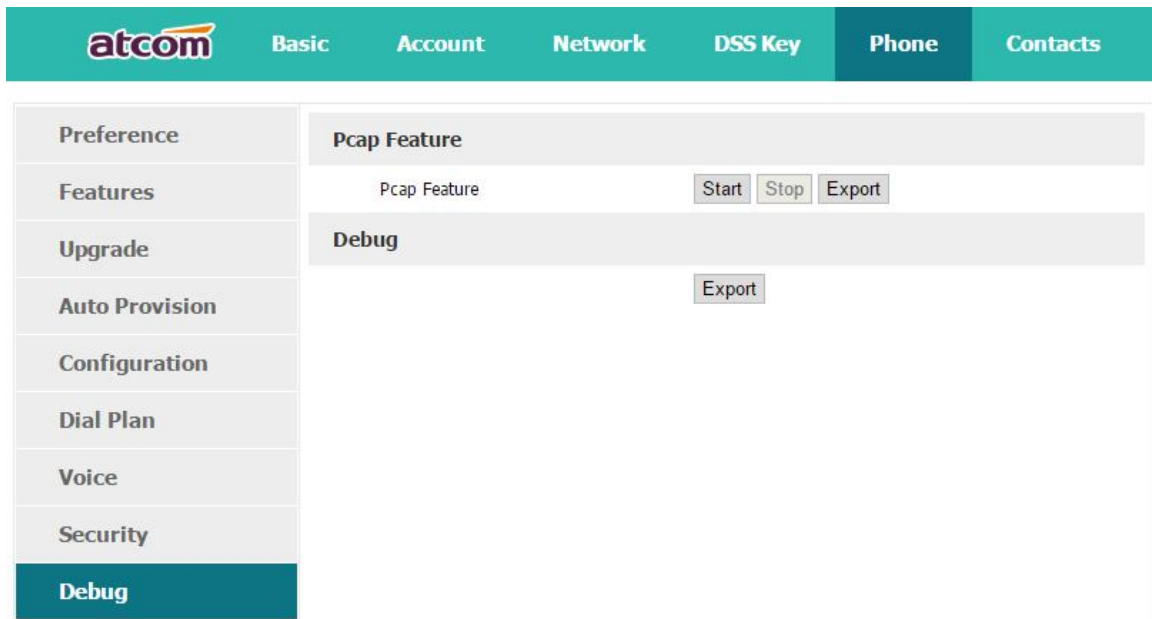

Click the button " Start" to start the capture and click the button "Stop" to end the capture. Then click the button "export" to download the capture file.

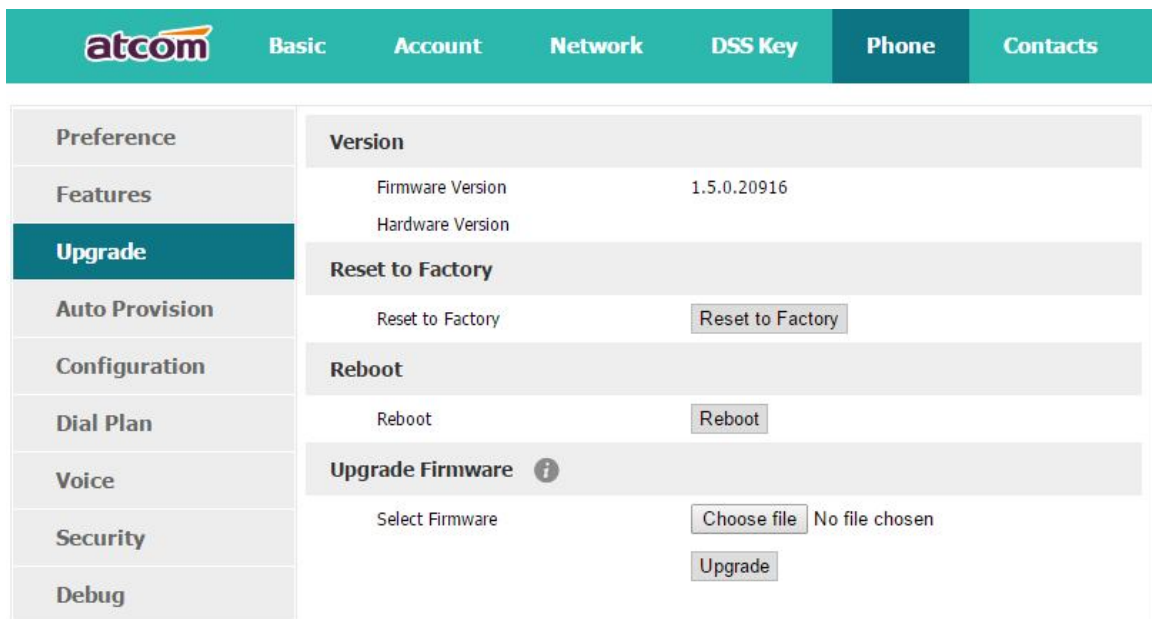

Before upgrading the firmware of phone, users are suggested to check the version of current firmware. Click the button "Choose file"to select the target local file and click "Upgrade" to process upgrading, this will cost a couple of minutes. And after reboot, the phone will be upgraded successfully.

### 5.3、 Auto Upgrade

User is able to configure the phone to upgrade automatically.

| Item                       | Description   |
|----------------------------|---|
| <b>Provisioning Server</b> | The address to save control file for auto upgrading, it can filled by http、https、tftp server、ftp server, for example, tftp://192.168.1.111/upgrade_control_file.xml |
| <b>User Name</b>           | The username to access the file server  |
| <b>Password</b>            | The password to access the file server  |
| <b>AES Key</b>             | If the configuration file has been encrypted, the AES key will be used to decrypt for auto-upgrading  |
| <b>Check New Config</b>    | If set this parameter as "On", the phone will do some check for upgrading, and it will upgrade automatically once the conditions are met                            |
| <b>Repeatedly</b>          | If set this parameter as "On", the phone will do some check for upgrading after "Interval(minutes)", and it will upgrade automatically once the conditions are met  |

|                          |   |
|--------------------------|---|
| <b>Interval(minutes)</b> | This parameter is configurable once the Repeatedly is "On"  |
| <b>Weekly</b>            | If set this parameter as "On", the phone will do the check for upgrading at a certain time in every week                |
| <b>Time</b>              | The time range that the phone do the check for upgrading every week, and it's configurable once the Repeatedly is "On"  |
| <b>Day of week</b>       | The day of week that the phone do the check for upgrading every week, and it's configurable once the Repeatedly is "On" |

The sample of control file:

```
-----  
<?xml version="1.0"?>  
  
<AUTOUPDATE Model="R3">  
  
<Config URL="http://www.atcom.com.cn/temp/$MAC.tar.gz"/>  
  
<PhoneBook URL="tftp://192.168.1.190/phonebook.xml"/>  
  
<Firmware MD5="cadfadfaeqedadfadfa"  
  
URL="http://www.atcom.com.cn/temp/R3-V1.5.1.fw"/>  
  
</AUTOUPDATE>  
-----
```

**\$MAC.tar.gz** refers to the specified files that named as the phones' MAC address, the phone will find the tar.gz file which named as its MAC address automatically once a phone uses this control file to upgrade the Config file at the specified location, for example, a R3(s)'s MAC address is EA:F5:GA:54:4D:DR, the corresponding control file should name as EAF5GA544DDR.tar.gz.

**MD5** is the property of a file, and it's always used for integrity checking, you can get it by using specified software. When upgrade the Firmware, the phone will compare the firmware's MD5 with the specified MD5, and it will refuse to upgrade if they are not the same.

## 5.4、 Export & Import configuration file

If user wants to set the same configuration on multiple phones, there is an easy way that export the configuration file from one phone and then import this file into other phones. This operation can be completed via Web only.

Note: This operation is available for the same models only.

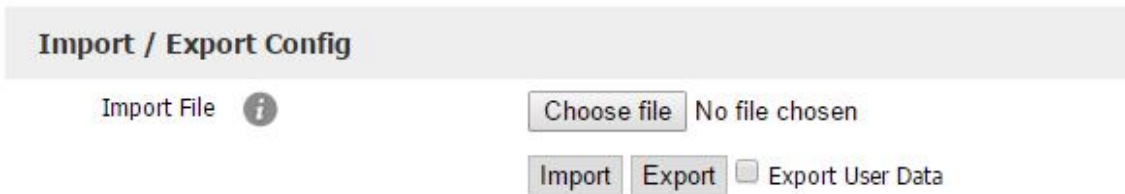

### 5.4.1、 Export configuration file

There is two ways to export the configuration files,

- Don't check the "Export User Data" and click "Export" directly, it will export the template of the configuration file;
- Check the "Export User Data" and then click "Export", it will export a configuration file that carries with user's configured data.

To modify the exported configuration file, you should to decompress it until you get a file names as configuration.

| Name          | Date modified    | Size |
|---------------|------------------|------|
| configuration | 2014/10/10 11:14 |      |
| config.tar.gz | 2014/10/10 11:14 | 9 KB |

The content of configuration file listed as below,

| Name     | Date modified    | Type        | Size |
|----------|------------------|-------------|------|
| Calllist | 2014/10/10 11:14 | File folder |      |
| Contacts | 2014/10/10 11:14 | File folder |      |
| DialRule | 2014/10/10 11:14 | File folder |      |
| Features | 2014/10/10 11:14 | File folder |      |
| Network  | 2014/10/10 11:14 | File folder |      |
| Phone    | 2014/10/10 11:14 | File folder |      |
| Setting  | 2014/10/10 11:14 | File folder |      |
| voip     | 2014/10/10 11:14 | File folder |      |

## 5.4.2. Import configuration file

Click the button "Choose file" to select the target file for importing, and then click the button "Import". The phone will be rebooted a couple of minutes later, and import successfully.

Note: If some part of the configuration file has been modified manually, it must be re-compressed as the format of "tar.gz", it should be compress by linux.

## 5.5. Export System log

When the phone doesn't working well, System log is the best assistant tools for trouble shooting, all operation details has been recorded. This operation is available via Web only.

### Export System Log

Log Location  Local  Server 

Server Name

Log Level

| Item                | Description  |
|---------------------|--|
| <b>Log Location</b> | You can import the system log to local PC or send to remote Server.  |
| <b>Server Name</b>  | User must fill the address of server if you choose to export the system log to remote server.  |
| <b>Log Level</b>    | It defines the detail of system log as 5 different levels, Fatal, Error, Warning, Info, and Debug. The Debug level is the most detailed. |

## 5.6. Dial plan



The customized Dial Plan are available on R3 (s) , for example , the rule of replacement, Instant Calling, Area code, Restriction of Outbound.

Before customizing the dial plan, user must learn the basic grammar as below,

|    |   |
|----|---|
| .  | Represent a character or multiple ones, e.g., "6." can match "66","678","6plus" and so on   |
| x  | Represent one character, e.g., "6x" can match "61","62", " 6s" and so on  |
| [] | Represent a character in one range, e.g., " 83[0-5]18618"can match"83018618","83488618" and so on   |
| () | Represent the combination of characters, e.g., "([1-9])([2-7])3" can match "923","153","773" and so on  |
| \$ | Add a number after the character "\$" to define the location of the characters, e.g., use the prefix " 8([1-3])(.)" to replace "7\$2", the phone will call "7837" after dialing out "82837" |

Note: Any operations (add, modify or delete) on the current dial plan will be not effective until click "Save".

### 5.6.1、 Replace Rule

Dial plan "Replace Rule" means to replace a batch of complicated character string by some simple characters, to make a speed dial.

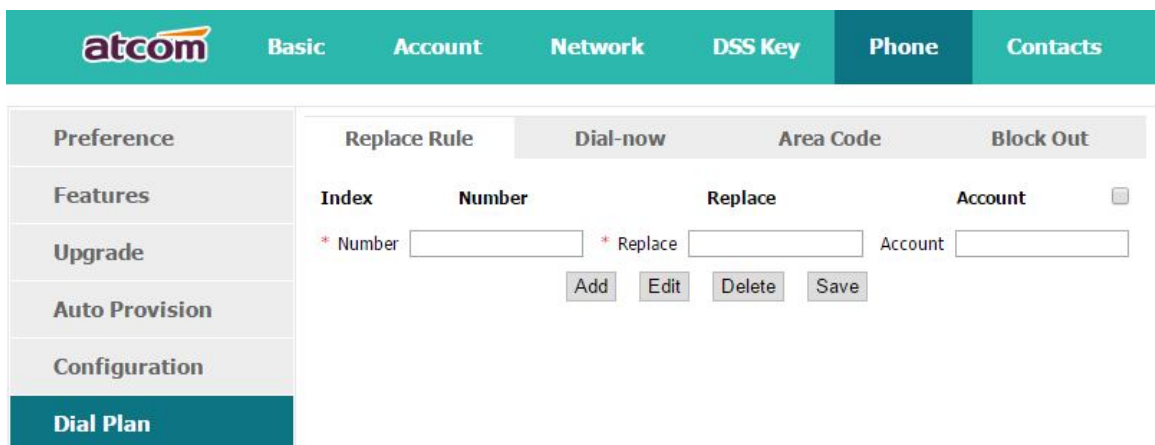

| Item | Description | Sample |
|------|-------------|--------|
|------|-------------|--------|

|                |   |   |
|----------------|---|---|
| <b>Number</b>  | The string works as replacer, not null  | Set Number as "6",<br><br>Set Replace as "6032",<br><br>Set Account as "1,3,4".<br><br>It means when dial 6, the phone will dial 6032 via the 1st available line in account 1,3,and 4 automatically |
| <b>Replace</b> | The string that to be replaced, not null  |   |
| <b>Account</b> | The account to apply this dial plan, blank or 1 to 4 is valid. Number 1 to 4 means account 1 to 4. If you want to apply this rule to account 1、3 and 4, just type in <b>1,3,4</b> ; And if keep it as blank, it means applying this dial plan to all accounts |   |
| <b>Add</b>     | Multiply replace rules can be configured in one phone, after one replace dial plan configured, click this button to add a new one   |   |
| <b>Edit</b>    | The existed replace dial plans are editable. The specified dial plan should be selected until it is covered with orange and the input fields "Number" and "Replace" shows the details correctly. After modifying, click button "Edit" to make it to be effect |   |
| <b>Delete</b>  | Delete one added or saved replace dial plan or multiple ones, click the frame after the specified replace dial plan before delete it, and then click button "Delete"  |   |
| <b>Save</b>    | Any alteration won't take effect until the button "Save" is clicked.  |   |

### 5.6.2、Dial-now

Dial plan "Dial-now" permits the corresponding phone to be dialed instantly without pressing the soft key "Dial", once the input has been matched. It works like a hotline.

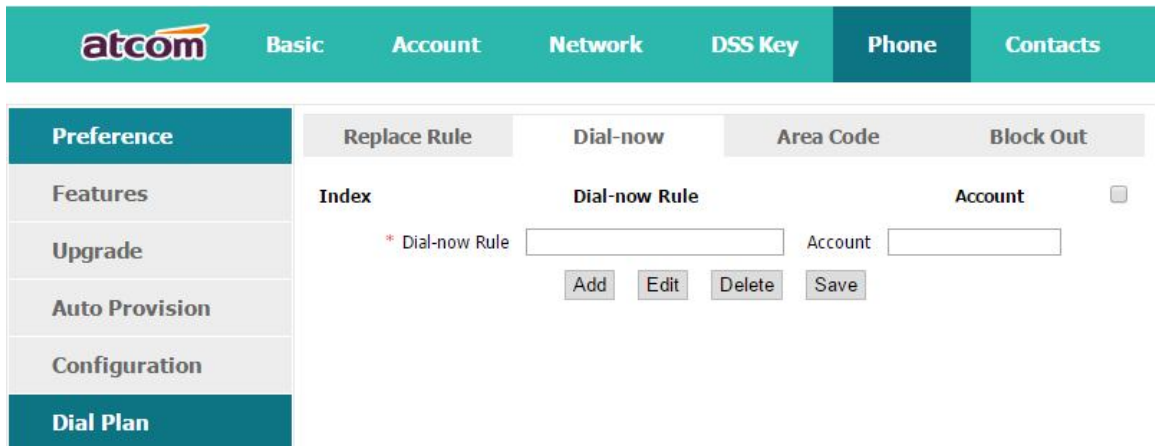

| Item                 | Description   | Sample   |
|----------------------|---|--|
| <b>Dial-now Rule</b> | The string to be dialed out automatically by the phone  | Set "Dial-now Rule" as 6xxx, keep "Account" as null  |
| <b>Account</b>       | The account to apply this dial plan, blank or 1 to 4 is valid. Number 1 to 4 means account 1 to 4. If you want to apply this rule to account 1、3 and 4, just type in <b>1,3,4</b> ; And if keep it as blank, it means applying this dial plan to all accounts   | It means the phone will use the 1st available account to call 6033 after "Dial-now Time-out" seconds when  |
| <b>Add</b>           | Multiply dial-now rules can be configured in one phone, after one dial-now dial plan configured, click this button to add a new one   | inputting four figures begin with 6  |
| <b>Edit</b>          | The existed dial-now dial plans are editable. The specified dial plan should be selected until it is covered with orange and the input fields "Number" and "Dial-now" shows the details correctly. After modifying, click button "Edit" to make it to be effect | Note: Dial-now rule is different with hotline. The Dial-now rule will take effect when input numbers matches the dial plan, and hotline takes effect in situation that the phone is in dialing state |
| <b>Delete</b>        | Delete one added or saved dial-now dial plan or multiple ones, click the frame after the specified dial-now dial plan before delete it, and then click button "Delete"  |  |
| <b>Save</b>          | Any alteration won't take effect until the button "Save" is clicked.  |  |

Set "Dial-now Time-out" via web: **Phone**→**Features**→**General Information**→**Dial-now Time-out (secs)**.

### 5.6.3、Area Code

Dial plan "Area Code" has been defined to identify each different area. To call a phone number of other areas, user must add the area code to be in front of the phone number. For convenience, area code has been recommended to be configured while frequently dialing to that type of phone number.

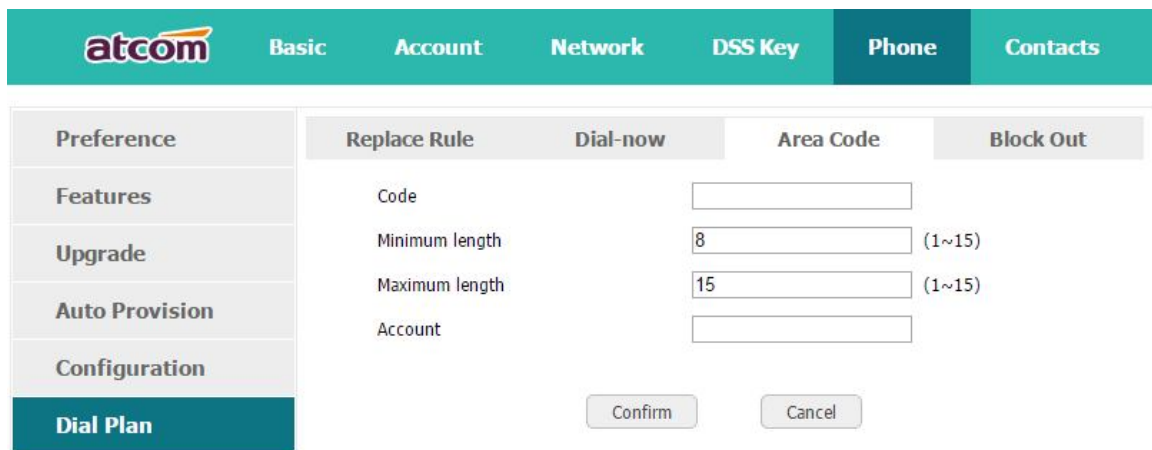

| Item                  | Description   | Sample   |
|-----------------------|---|--|
| <b>Code</b>           | The area code dialed before the number  | Set "Code" as "0086577",<br>Set "Account" as "4",  |
| <b>Minimum length</b> | The minimum length of the number input to activate the area code dial plan  | Set "Minimum length" as "5".   |
| <b>Maximum length</b> | The maximum length of the number input to activate the area code dial plan  | It means when dialing 83018618 with the 4 <sup>th</sup> account, the phone will dial 0086577 before it.  |
| <b>Account</b>        | The account to apply this dial plan, blank or 1 to 4 is valid. Number 1 to 4 means account 1 to 4. If you want to apply this rule to account 1、3 and 4, just type in <b>1,3,4</b> ; And if keep it as blank, it means applying this dial plan to all accounts | <b>Note: If the length of the number input in the dial UI is not between minimum length and the maximum length, area code will not take effect</b> |
| <b>Confirm</b>        | Apply this dial plan  |  |
| <b>Cancel</b>         | Recover all input fields to the state that saved at latest time   |  |

### 5.6.4、Block Out

Dial plan "Block out" is used to prohibit the phone number outgoing call from some accounts.

| Item                    | Description  | Sample   |
|-------------------------|--|--|
| <b>Block Out Number</b> | The number that prohibited   | Set "Block Out Number 1" as "10086"  |
| <b>Account</b>          | The account to apply this dial plan, blank or 1 to 4 is valid. Number 1 to 4 means account 1 to 4. If you want to apply this rule to account 1, 3 and 4, just type in <b>1,3,4</b> ; And if keep it as blank, it means applying this dial plan to all accounts | Set "Account" as "2,4"<br><br>It means the phone will enter the "Call End" UI when dial "10086" with account 2 and 4 |
| <b>Confirm</b>          | Apply this dial plan   |  |
| <b>Cancel</b>           | Recover all input fields to the state that saved at latest time  |  |

## 6、FAQ

### 6.1、How to reset to factory

There are 3 methods for factory reset:

1. Factory reset via phone:

- a) Press the key 
- b) Select "Settings", then press the soft key "Enter"
- c) Select "Advanced Settings", then press the soft key "Enter"
- d) Input the access password, then press the soft key "Enter"
- e) Select "Reset to factory", then press the soft key "Enter"
- f) Press the soft key "OK", then the phone will be reboot and resumed to factory default settings

2. Factory reset via Web:

- a) Key in the IP address of phone with a browser,
- b) Access the webpage of phone as the role of "admin", username/password is admin/admin.
- c) Select "Phone"
- d) Select "Upgrade"
- e) Click the button "Reset to Factory"
- f) Click the button "OK"

3. Factory reset during starting:

- a) Hold the key "\*" and "#" while power on for 5 seconds
- b) The phone will be reboot and resumed to factory default setting

## 6.2、 Upgrade the firmware on safe mode

If the phone can't be started successfully, user is able to upgrade the firmware on post mode,

- a) Setup a TFTP Server and set the PC's IP address as "192.168.1.200"
- b) Copy the firmware file we supplied to the root menu of TFTP Server, modify the file's name as R3.tar.gz and decompress it, then modify the corresponding file's name :  
  
uImage rename Rainbow3.kn, rootfs.nand rename Rainbow3.fs, Rainbow3-v1.8.2.22501.app rename Rainbow3.fw, logo\_data rename Rainbow3.lg
- c) Ensure the TFTP Server and phone are connected to the same network switch and both reachable
- d) Long Press the key "\*" and "1" to upgrade the kernel file, long Press the key "\*" and "2" to upgrade the firmware file, long Press the key "\*" and "3" to upgrade the App file, long Press the key "\*" and "4" to upgrade the logo file, and then plug in power until upgrade word displayed on LCD
- e) The phone will start downloading file from TFTP server
- f) After downloading completed, the phone will be automatically upgraded
- g) After upgrading completed, the phone will be started with the factory default settings

## 6.3、 How to make IP Peer to Peer call

To make a IP peer to peer call, user should press "\*"to input "." that in the IP address. For example, to dial "192.168.1.100", just need input "192.168.1.100".

## **7、 Troubleshooting**

### **7.1、 The phone is failed to register to SIP server**

1. First of all, check the IP address. If the LAN port is DHCP, please ensure the DHCP server has been enabled.
2. Check the network gateway
3. Check the DNS
4. Make sure the input account matched the one provided by Service Provider
5. Make sure SIP Server has been enabled already
6. Make sure the Port of SIP Server, it's 5060 by default
7. If the pbx account is public IP, please check the RPort and Stun
8. If the pbx account is public IP, please check the keep alive

### **7.2、 The phone is failed to gain IP address**

1. Make sure the network cable has been plugged into the LAN port
2. Make sure the network cable or port of network switch are working fine,
3. Make sure the DHCP server has been enabled, and there are available IP address
4. Try to set the LAN port as Statics IP

### **7.3、 Only one party can hear from another on calling**

1. Try to make a IP peer to peer call, to make sure the mic and speaker are working fine
2. Enable STUN via Web
3. Set the address of STUN Server, for example [stun.sipgate.com](http://stun.sipgate.com)
4. Present this operation above



5. Try to make a normal call again

## 8、Abbreviation

DND: Do Not Disturb

CFWD: Call Forward

Blind: Blind Transfer

Conf: Conference

Num: Number

SIP: Session Initiate Protocol

RTP: Real-time Transport Protocol

SDP: Session Description Protocol

VPN: Virtual Private Network

VLAN: Virtual Local Area Network

QoS: Quality of Service

Syslog: System log

UDP: User Data Protocol

TCP: Transmission Control Protocol

TLS: Transport Layer Security Protocol

BLF: Busy Lamp Field

DNS: Domain Name System

SRTP: Secure Real-time Transport Protocol

NTP: Network Time Protocol

VAD: Voice Activity Detection

CNG: Comfort Noise Generator